



Addition to the operating and installation instructions
Cascading of **LegaDrive** control units

Contents

1. Definition of cascading	3
1.1 Master	3
1.2 Slave	3
2. Startup	4
2.1 Necessary components	4
2.2 Connecting the drives	4
2.3 Connecting the handset	4
2.4 Connecting the cascading cable	5
2.5 Connecting the power supply cable	5
2.6 Initial reset of the lifting columns	6
3. Operation of the cascaded network	7
3.1 Changes to the cascading network	8
3.2 Resetting the control unit to factory settings (S0 menu)	8
4. Collision detection	10
5. Appendix	11
5.1 Examples of possible configurations	11
5.1.1 Network with 2 control units Compact-e-2 and 4 lifting columns	11
5.1.2 Network with 2 control units Compact-e-3 and 6 lifting columns	12
5.1.3 Network with 3 control units Compact-e-3 and 9 lifting columns	13
5.2 Illustrations	14
5.2.1 Short cascading cable	14
5.2.2 Cascading cable with 3 connections	14
5.2.3 Connected cascading cables	15
5.3 Error messages for cascading on the handset display	16

1. Definition of cascading

Cascading provides the capability of connecting up to four control units for operating as many as twelve lifting columns running in synchrony. The function of such a system will be described in the following.

1.1 Master

The master of a cascading system is the control unit to which a handset is connected. This control unit is the only one in the entire network that accepts handset instructions and therefore is the most important unit.

1.2 Slave

Slaves are control units that serve as extensions to the master and are connected to the master via special cascading cables. Handsets must not be connected to these control units.

	Note
	Handset instructions are not accepted by the cascading network if the handset is connected to a slave.

	Not
	A cascading network, consisting of two, three or four control units, is to be considered as a closed system. (Example: If, in the instructions, you are requested to interrupt the supply of electricity, this is to be performed for all control units within the network. Here, all control units are to be in the same electricity free state.)

2. Startup

	Note
	To ensure a correctly functioning system, it is recommended that these instructions are followed step by step, because otherwise considerable complications can arise.

	Note
	Do not connect a control unit that is not in the factory setting.

2.1 Necessary components

The following components are necessary to establish a functioning network:

Network of 2 control units

- ① 1 handset Touch Comfort
- ② 2 control units Compact e-2 / -3
- ③ 2 power cables
- ④ 1 cascading cable, short
- ⑤ up to 4 / 6 drives

Network of 3 control units

- ① 1 handset Touch Comfort
- ② 3 control units Compact e-2 / -3
- ③ 3 power cables
- ④ 3 cascading cables
- ⑤ up to 6 / 9 drives

Network of 4 control units

- ① 1 handset Touch Comfort
- ② 4 control units Compact e-2 / -3
- ③ 4 power cables
- ④ 4 cascading cables
- ⑤ up to 8 / 12 drives

	Note
	You will find information on the various cascading cables in Section 5.2.

2.2 Connecting the drives

The motors can be allocated to the control units in any way.

2.3 Connecting the handset

You can connect the handset to the seven-pole handset socket (HS) on the control unit that is to act as the master in operation.

	Note
	We recommend the use of a comfort handset with display and memory function for the cascading system.

	Note
	Examples of possible drive configurations are to be found in Section 5.1.

	Note
	The control unit that, in the factory setting, first detects a pressed button on the handset is declared as being the master - therefore the handset may only be connected to the control unit intended for this.

2. Startup

2.4 Connecting the cascading cable

Connect your control unit using the cascading cable intended for this to the logic connector DATA to enable operation in the network.

	Warning
	For the operation of three or four control units, the long cascading cable with three connections is to be used.

	Warning
	For the operation of two control units, the short cascading cable with two plugs can be used.

	Note
	You will find information on the various cascading cables in Section 5.2.

	Note
	Examples of possible cascading networks and the components to be used with these are to be found in Section 5.1.

	Note
	To guarantee the best possible operation, it is recommended that the cascading cables are laid in such a way that no mechanical stresses of any type (for example twisting) can act on them.

	Note
	If the cascading cable is to be removed, the snap in mechanism must be opened by pressing prior to unplugging the plug.

2.5 Connecting the power supply cable

Prior to supplying any control units with electricity, ensure that all previous steps have been performed correctly and that the network is set up as per one of the networks depicted in Section 5.1.

	Warning
	Prior to connecting the power supply cables, check again that <ul style="list-style-type: none">· the mains voltage is the same as the mains voltage shown on your control unit's rating plate,· all components are connected to the right sockets.

2. Startup

2.6 Initial reset of the lifting columns

Once the control units have been connected to the electricity supply, it is necessary to perform a reset of the lifting columns, because in this process the addressing of the cascading network will also be performed.

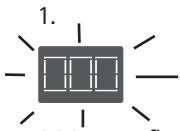

1. **000** must flash on the display. This indicates that the system is waiting for a reset.

2.



Press the **desk top down** button.

The lifting columns should now be driven to the reset position at reduced speed. Do not release the button until the final position, indicated via a click code, is reached!

3.

Wait for at least three seconds after the reset. During this time, the lifting column detection will be completed and saved.

4.



The display now shows the current desk top position.



Warning

Notice: Be sure to check either directly during or immediately after the reset whether the respective lifting columns also move

➔ **The system can otherwise be damaged through oblique lifting or retracting.**



Note

If not all of the lifting columns move in accordance with the parameterisation, all electrical connections are to be checked in the first instance (cascading cable, motor cables, etc.). Then set the control units to the factory setting (see Section 3.2) and perform a reset again.



Note

The reset must be completed fully, otherwise the system is not ready for operation.



Note

If errors occur during the reset (error message on the display, incorrect behaviour of the lifting columns), the cascading network must be set to the factory setting (S0 menu).



Note

You will find information on further handset functions in the document Operating and installation instructions LegaDrive.





Note

It takes approximately five seconds before the lifting columns begin the reset movement.

3. Operation of the cascaded network

To ensure that the cascading network operates safely, please observe the following safety advice:

	<p>Warning</p> <p>Keep children away from the electrically height adjustable workplace as well as from control units, handset, cables and lifting columns! They could be injured by voltage.</p>
	<p>Warning</p> <p>Unplug the power supply cable from the power socket in the event of a thunderstorm or prolonged absence! Otherwise the system might be damaged from mains related voltage surges.</p>
	<p>Note</p> <p>You will find the functions of the LegaDrive control unit in the operating instructions Operating and installation instructions LegaDrive.</p>

The following features are supported in the individual operation types:

	Single control unit		Cascaded network	
	with Compact-e-2	with Compact-e-3	with Compact-e-2	with Compact-e-3
Maximum number of motors	2	3	8	12
Save and recall memory positions	x	x	x	x
Changing the desk top height display	x	x	x	x
Manual reset	x	x	x	x
Low speed areas	x	x	x	x
Duty cycle	x	x	x	x
Pedestal stop / shelf stop	x	x	x	x
Plug detection	x	x	x	x
Auto detect number of drives	x	x	x	x
Intelligent System Protection ISP (collision detection)	x	x	x	x
Drive back	x	x	x	x
Changing the display unit (cm/in)	x	x	x	x
Resetting the control unit to factory settings (S0 menu)	x	x	x	x
Displaying errors on the handset display	x	x	x	x
Click codes	x	x	x	x
Errors indicated by LEDs	-	x	-	x

3. Operation of the cascaded network

3.1 Changes to the cascading network

Should it be necessary to replace one or more control units within a cascading network, the following procedure is to be observed:

1. Prior to replacing the affected control unit with a new one, reset all control units of the planned network to the factory settings (see section 3.2).
2. Disconnect the entire cascading network from the electricity supply
3. Establish the cascading network (see Section 2)

	Note
	Do not connect a control unit that is not in the factory settings.

3.2 Resetting the control unit to factory settings (S0 menu)

This function allows you to return the control unit to the factory settings.

1. 

Simultaneously press **memory position button 1**, **memory position button 2** and the **desk top up** button. Keep this button combination pressed for approx. 3 seconds. Now release the buttons.



The display shows **S** and a number, e.g. **S 1**.

2. 

Press and release the **desk top up** button until the display shows **S 0**.



The display shows **S 0**.

3. 

Press the memory button. The display shows **E70**.





4. Unplug the mains power connection cable and plug it back in again after approximately five seconds. The control unit is reset to the factory settings. The control unit is now in the same state as it was before you put it into operation for the first time.

	Note
	In this way, it is possible to disband a cascaded network and to use each control unit as a single control unit again or to establish a new network.

	Note
	Calling up the S0 menu will reset all control units in the network to the factory settings.

	Note
	It is imperative that the network is reset to the factory setting prior to any changes being made (parameters, configuration).

	Note
	The menu has a timeout of five seconds - this means that the menu will close automatically and without saving the settings if no inputs are made within five seconds.

	Note
	On selecting the menu, the display shows S and a number, e.g. S 1 . This number depends on the control unit's parameters.

	Danger
	Danger! If lifting columns are to be replaced in a system, it is imperative that the lifting columns are reset to their factory settings first and that a manual reset is performed.

4. Collision detection

The integrated collision detection system ISP (Intelligent System Protection) is also active during operation of a cascaded network with several control units.



Danger

Danger!

In exceptional circumstances, despite the collision detection system ISP, there can be a risk of crushing because motor shutdown is not only governed by the control unit but also by the interaction of the mechanical and electronic components! Furthermore, shutdown sensitivity is also influenced by the mechanical components, the motor and ambient conditions. Therefore, the manufacturer cannot entirely rule out this residual risk and does not accept any liability.



Note

The sensitivity and the achievable shutdown threshold of the collision detection system ISP depend on the entire system (mechanical and electrical components). Contact the manufacturer to determine the suitability of the ISP for a height adjustable table.

5. Appendix

5.1 Examples of possible configurations

5.1.1 Network with 2 control units Compact-e-2 and 4 lifting columns

For a cascading network with two control units, the short cascading cable with two plugs can be used.

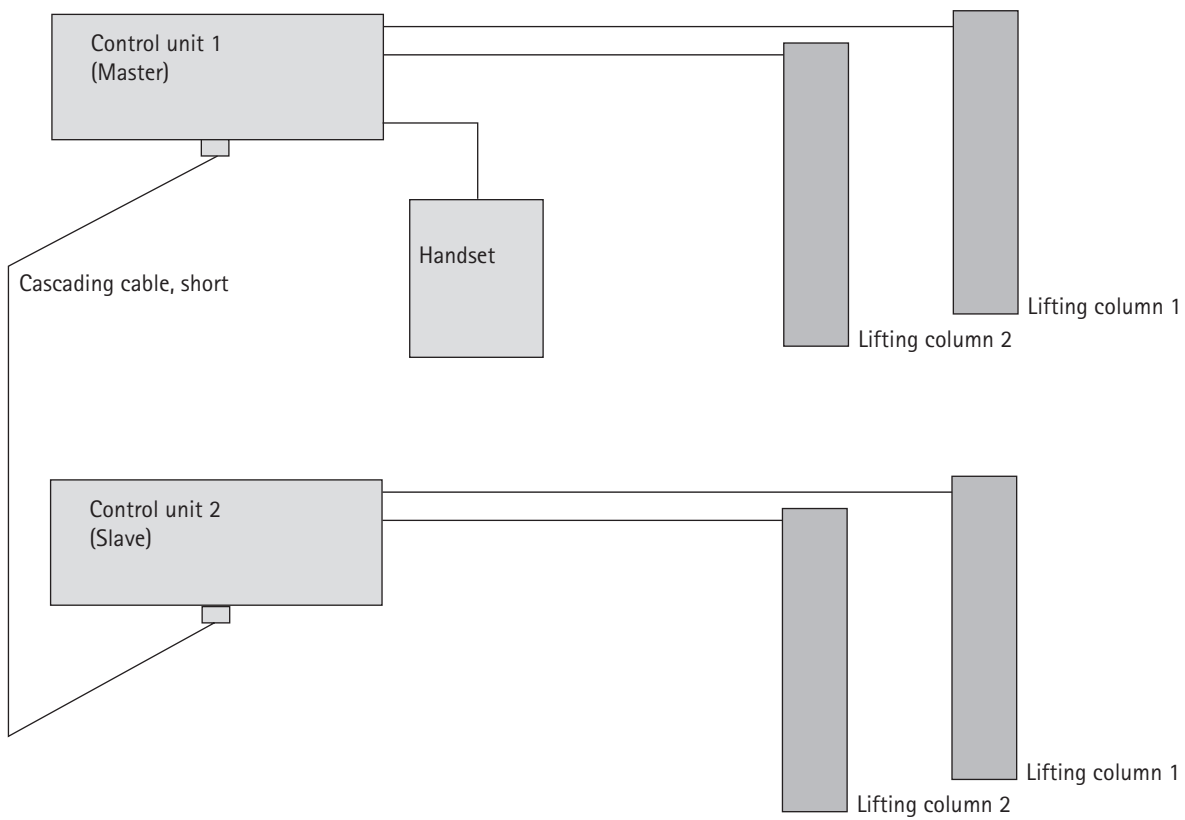

Figure 1: Network with 2 control units Compact-e-2 and 4 lifting columns

5. Appendix

5.1.2 Network with 2 control units Compact-e-3 and 6 lifting columns

For a cascading network with two control units, the short cascading cable with two plugs can be used.

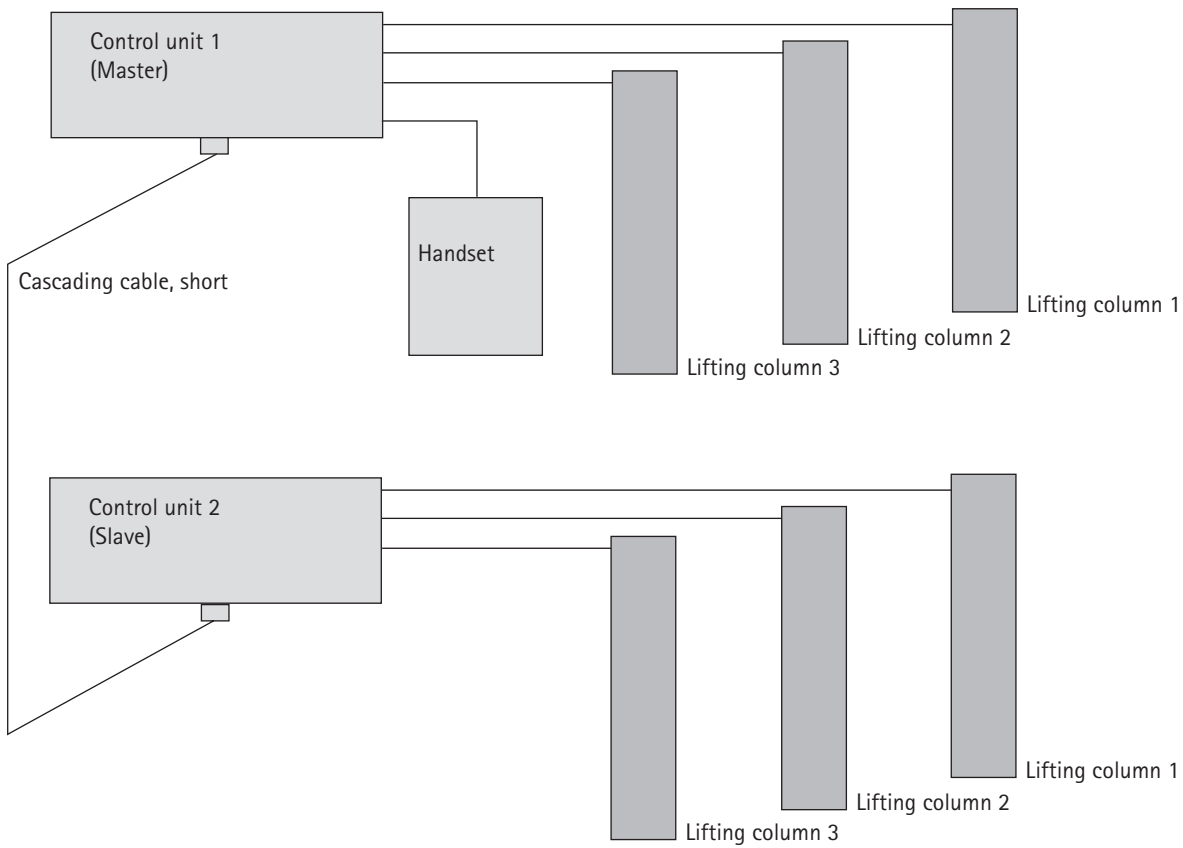

Figure 2: Network with 2 control units Compact-e-3 and 6 lifting columns

5. Appendix

5.1.3 Network with 3 control units Compact-e-3 and 9 lifting columns

For a cascading network with three or four control units, the long cascading cable with three connections is to be used.

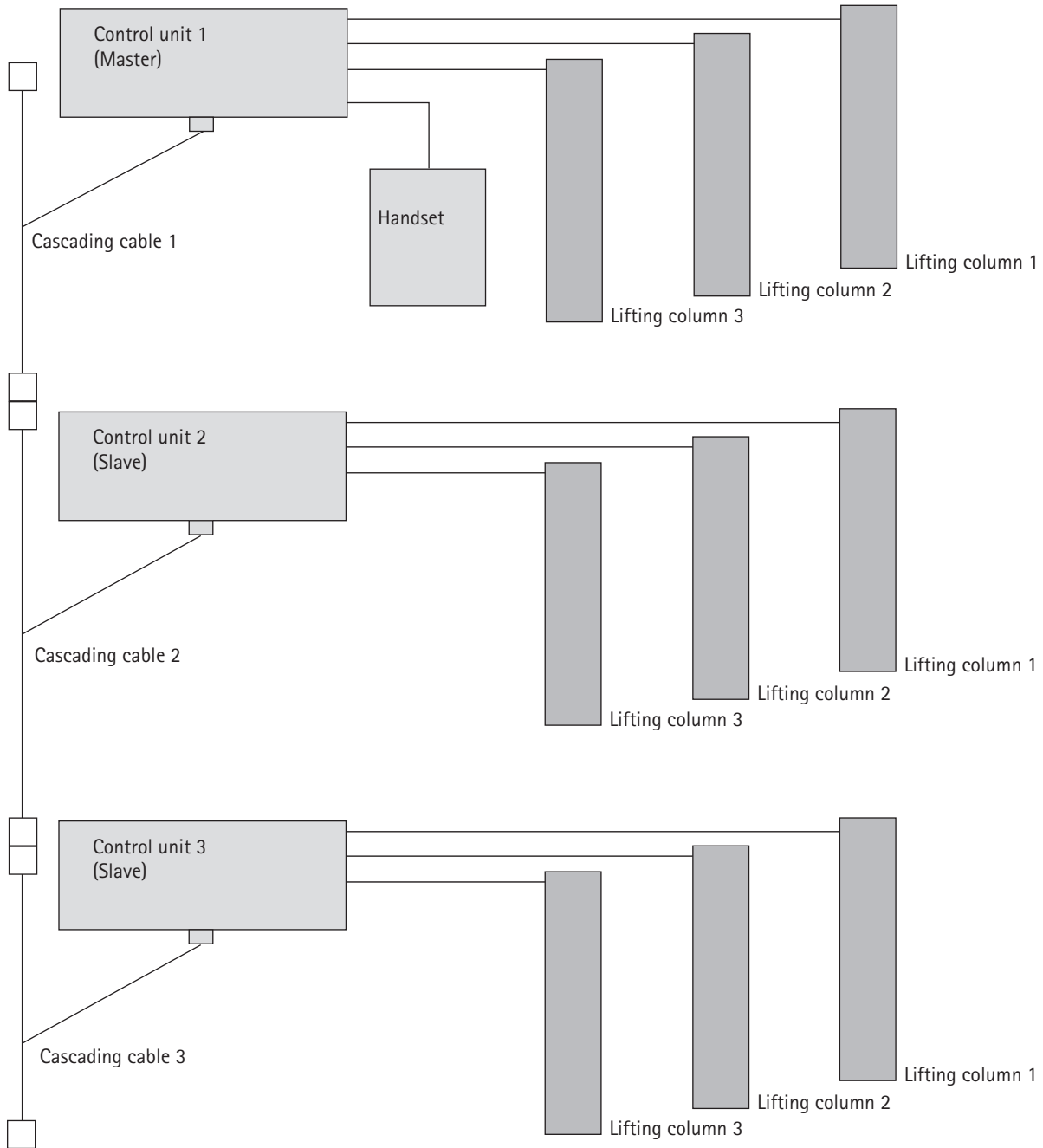

Figure 3: Network with 3 control units Compact-e-3 and 9 lifting columns

5. Appendix

5.2 Illustrations

5.2.1 Short cascading cable

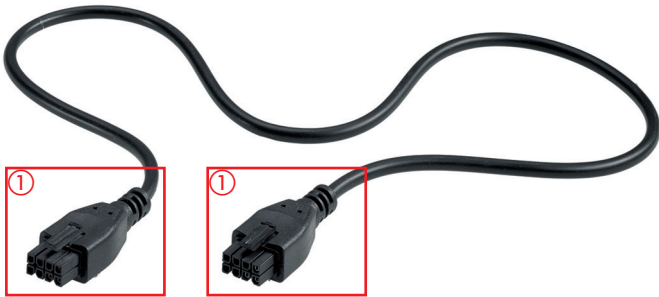
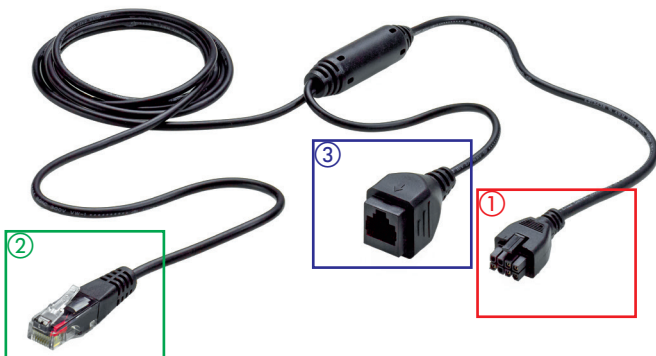

Figure 4: Short cascading cable with 2 plugs

- ① The two plugs are for the connection of two control units via the DATA logic connector, to enable these to be used in a cascaded network.

5.2.2 Cascading cable with 3 connections



One cascading cable of this type is necessary for each control unit in the cascading network.

- ① Plug 1 is for the connection of two, three or four control units via the DATA logic connector, to enable these to be used in a cascaded network.
- ② / ③ Plug 2 and socket 3 are for the connection of additional cascading cables of the same type.

5. Appendix

5.2.3 Connected cascading cables

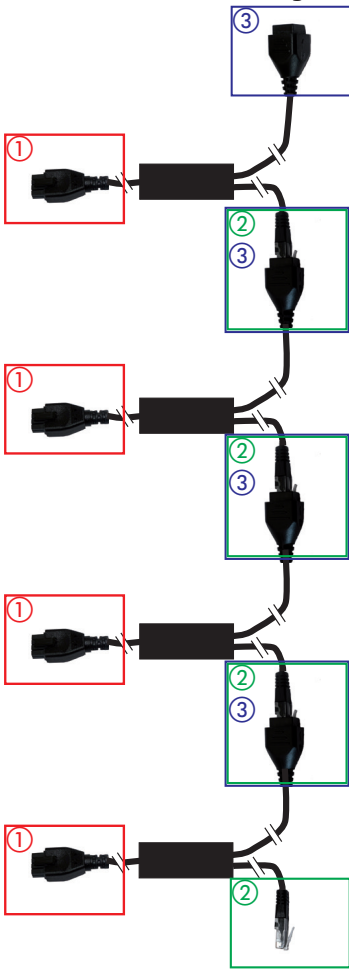

Figure 6: 4 connected cascading cables

- ① Plug 1 is for the connection of two, three or four control units via the DATA logic connector, to enable these to be used in a cascaded network. One cascading cable of this type is needed per control unit.
- ② / ③ The remaining plug 2 and the remaining socket 3 remain open.

5.3 Error messages for cascading on the handset display



The display shows E + an error number.

	Description	Remedy
93	Connection error in the cascaded network The error is shown on the display for 15 seconds, after which time the control unit switches when necessary to the reset mode with 000 flashing in the display.	Check all cable connections and try to perform a reset. If the reset is not possible, disconnect all control units from the electricity supply. Wait for at least five seconds and reconnect all control units to the electricity supply. Try to perform a reset again. If a reset is still not possible after this, contact Customer Service.

i
Note

A complete list of error messages is available in the document Operating and installation instructions LegaDrive.

Important: If the unplugging and plugging back in (synonymous with switching off and on) of a control unit is suggested in the corrective actions, this is to be performed on all control units in the cascaded network! Here, all control units are to be in the same electricity free state!

i
Note

Note: If a lifting column is unplugged in operation and the plug detection activates, a reset can be necessary.

i
Note

Note: If not all control units are in standby when the electricity supply of at least one control unit is disconnected, this will be interpreted as connection error E93.

i
Note

A manual reset is necessary if, during height adjustment, there is a power cut or the power cable is unplugged.



Paul Hettich GmbH & Co. KG
Vahrenkampstr. 12-16
32278 Kirchlengern

Technik für Möbel

