



## Operating and installation instructions LegaDrive Eco

(Copy of the original)

Operating and installation instructions  
under EC Machinery Directive 2006/42/EC,  
Annex VI for partly completed machinery

Lifting column system for an electrically  
height adjustable workstation

Type:                    LegaDrive Eco

Manufacturer:        Paul Hettich GmbH & Co. KG  
                              Vahrenkampstr. 12-16  
                              32278 Kirchlengern

Year built:            2018

Date / effective:    2019-01 / 00

## Foreword



### Warning

Read these operating and installation instructions carefully in order to obtain a thorough understanding of the lifting column and how to install it. Install the lifting column as described in these instructions so as to avoid injury and damage to the lifting column. Do not install the lifting column on the basis of suppositions. Keep these operating and installation instructions to hand and consult them if you are in any doubt as to carrying out any particular procedure.

Before installing the lifting column, settle any unanswered questions first by consulting **Paul Hettich GmbH & Co. KG**.

These operating and installation instructions are a separate part of the overall documentation. The overall documentation must be made available to installation, operating and servicing personnel.

### Customer Service

Hettich Marketing- und Vertriebs GmbH & Co. KG  
Vahrenkampstr. 12-16  
D-32278 Kirchlengern

Please contact the person responsible at the  
Hettich Customer Service.

Copyright to these operating and installation instructions

© 2014 held by Paul Hettich GmbH & Co. KG

The copyright to these operating and installation instructions remains with **Paul Hettich GmbH & Co. KG**.

These operating and installation instructions are intended for personnel installing the LegaDrive Eco. It contains regulations and drawings of a technical nature that must not be duplicated either in whole or in part, distributed, used without permission for advertising purposes or communicated to others.

# Contents

<b>Subject matter</b>	<b>Page</b>		
Foreword	2	6.2.4 Programming / logging off wireless handset	30
Contents	3	6.2.4.1 Replacing the battery	30
List of figures	4	6.3 Overall configuration (example)	31
<b>1. Introduction</b>	<b>5</b>	6.4. Reset on starting up for the first time	31
1.1 Information on signs, symbols and markings	5	<b>7. Operation</b>	<b>32</b>
1.2 Information for the owner	6	7.1 Basic functions	32
<b>2. General</b>	<b>7</b>	7.1.1 Upward desk top movement	33
2.1 Intended use	7	7.1.2 Downward desk top movement	33
2.2 Foreseeable incorrect use	7	7.2. Display functions	34
2.3 Package contents	8	7.3. Display lock	34
2.4 Liability	9	7.4 Extended functions	35
<b>3. Safety</b>	<b>10</b>	7.4.1 Memorising a desk top position	35
3.1 Safety advice for the user company	11	7.4.2 Adjusting desk top to a memorised position	36
3.2 Safety information for the operating personnel	11	7.4.3 Changing desk top position height display	36
3.3 Safety advice for maintenance work	12	7.4.4 Manual reset	37
3.4 Noise	12	7.5 Software related functions	37
3.5 Hazards from electrical energy	12	7.5.1 Low speed areas	37
3.6 Particular hazard spots	13	7.5.2 ON time monitor	37
3.7 Residual risk	13	7.5.3 Safety zone	38
3.8 Training/instruction	14	7.5.4 Pedestal stop and shelf stop positions	38
3.9 Personnel qualification	14	7.5.5 Plug detection	40
<b>4. Description of the product</b>	<b>15</b>	7.5.6 Auto detect number of drives	40
4.1 Technical specifications	15	7.5.7 Collision detection (ISP)	40
4.2 Controls	15	7.5.8 Collision detection (Drive back)	41
4.2.1 Power supply cable	15	7.5.9 Changing desk height unit (cm or inch)	41
4.2.2 Control unit	16	7.5.10 Returning control unit to factory settings	
4.2.3 Handset	16	(S0 menu)	42
4.3 Protective guards	18	<b>8. Troubleshooting</b>	<b>44</b>
4.3.1 Mechanical protective guards	18	8.1 Safety advice	44
4.3.2 Software related protective guards	18	8.2 Malfunctions	45
<b>5. Transportation and installation</b>	<b>19</b>	8.2.1 Potential malfunctions and how to remedy them	45
5.1 Transportation	19	8.2.2 Faults indicated on the handset display	46
5.2 Installation	19	8.2.3 Control click codes	47
5.2.1 Installing lifting column	20	<b>9. Servicing and maintenance</b>	<b>48</b>
5.2.2 Installing control unit	21	9.1 Safety advice	48
5.2.3 Installing handset	21	9.2 Checking safety devices	50
5.2.3.1 Installing LegaDrive Basic handset	21	9.3 Labelling, information signs	50
5.2.3.2 Installing LegaDrive Touch Basic handset	22	<b>10. Taking out of service</b>	<b>51</b>
5.2.3.3 Installing LegaDrive Touch Basic Inlay handset	22	<b>11. Disposal</b>	<b>52</b>
5.2.3.4 Installing LegaDrive Touch Inlay handset	23	11.1 Protecting the environment	52
5.2.3.5 Installing LegaDrive Touch Comfort handset	24	11.2 Disposal	53
5.2.3.5.1 Notes on Push to open function	25	<b>12. EC Declaration of Incorporation</b>	<b>54</b>
5.2.3.5.2 Notes on control panel	25		
5.2.3.6 Installing the wireless handset Basic	26		
<b>6. Start-up</b>	<b>27</b>		
6.1 Starting up for the first time	28		
6.2 Startup procedure	28		
6.2.1 Plugging in drives / lifting columns	28		
6.2.2 Plugging in handset / wireless receiver	29		
6.2.3 Plugging in power supply cable	29		

# List of figures

Figure	Page		Page		
Fig. 1:	Example showing overall product	8	Fig. 33:	Cable loop of 10 cm min. for the push-to-open feature	25
Fig. 2:	Lifting column (here: moved in and out)	8	Fig. 34:	Control panel detached from above from its anchorage	25
Fig. 3:	Example of a handset and a control unit	8	Fig. 35:	Spring end hooked into the lug below the slide	25
Fig. 4:	Various power supply cables	15	Fig. 36:	Pushing the control panel into the slide	25
Fig. 5:	Smartneo-2 control unit EU / US	16	Fig. 37:	Wireless handset Basic	26
Fig. 6:	LegaDrive Basic handset	16	Fig. 38:	Inserting / replacing the battery Button cell CR 2032	26
Fig. 7:	LegaDrive Touch Basic handset	16	Fig. 39:	Installing the wireless handset Basic	26
Fig. 8:	LegaDrive Touch Basic Inlay handset	16	Fig. 40:	Sockets on control unit	27
Fig. 9:	LegaDrive Touch Inlay handset	16	Fig. 41:	Sockets on control unit	28
Fig. 10:	LegaDrive Touch Comfort handset	17	Fig. 42:	Sockets on control unit	29
Fig. 11:	Wireless handset Basic	17	Fig. 43:	Wireless receiver	30
Fig. 12:	Receiver module for wireless handsets	17	Fig. 44:	Battery change	30
Fig. 13:	Lifting column protective enclosure	18	Fig. 45:	Example configuration	31
Fig. 14:	Attaching lifting column (viewed from below) to example foot extension	20	Fig. 46:	Display on LegaDrive Touch handset	34
Fig. 15:	Attaching lifting column (viewed from above) to example desk	20	Fig. 47:	The key symbol indicates activated display lock	34
Fig. 16:	Fixing points on control unit	21	Fig. 48:	The LegaDrive Touch Comfort handset lock is activated and deactivated by swiping to the left or right	34
Fig. 17:	LegaDrive Basic handset	21	Fig. 49:	The LegaDrive Touch Inlay handset lock is activated and deactivated by swiping to the left or right	34
Fig. 18:	Attaching LegaDrive Basic handset to example desk	21	Fig. 50:	Container-Stop- / Shelf-Stop-Position	38
Fig. 19:	LegaDrive Touch Basic handset	22			
Fig. 20:	Attaching LegaDrive Touch Basic handset to example desk	22			
Fig. 21:	LegaDrive Touch Basic Inlay handset	22			
Fig. 22:	Cut out for installing LegaDrive Touch Basic Inlay handset with rubber fins	22			
Fig. 23:	Attaching LegaDrive Touch Basic Inlay handset to example desk	22			
Fig. 24:	LegaDrive Touch Inlay handset	23			
Fig. 25:	Cut out for installing LegaDrive Touch Inlay handset with rubber fins	23			
Fig. 26:	Attaching LegaDrive Touch Inlay handset to example desk	23			
Fig. 27:	LegaDrive Touch Comfort handset	23			
Fig. 28:	Position for installing LegaDrive Touch Comfort handset	24			
Fig. 29:	Position of screw holes for installing LegaDrive Touch Comfort handset	24			
Fig. 30:	Attaching LegaDrive Touch Comfort handset to example desk	24			
Fig. 31:	Pressing the control panel to automatically extend it	25			
Fig. 32:	Lifting and pushing the control panel to retract it	25			

# 1. Introduction

These operating and installation instructions are intended to make it easier for you to become familiarised with the lifting column system and use its capabilities in the proper manner. These operating and installation instructions contain important information on installing the lifting column system safely and in the proper manner. Following them will help to avoid hazards, repair costs and down times, enhance reliability and prolong service life.





Existing national regulations on preventing accidents and on protecting the environment are also applicable.

These operating and installation instructions must be read and applied by all persons instructed to carry out work on the system's components, e.g.:

- Installation
- Operation
- including troubleshooting while working, care, disposal
- Maintenance
- Servicing, inspection, repair and
- Transportation.

## 1.1 Information on signs, symbols and markings

The safety advice in the operating and installation instructions is structured as follows:

	<b>! Danger</b> <b>Danger!</b> This danger note draws attention to an immediately dangerous situation that will lead to death or serious injuries if the safety measures are not followed.
	<b>! Warning</b> <b>Warning!</b> This danger note draws attention to a potentially dangerous situation that may lead to death or serious injuries if the safety measures are not followed.
	<b>! Caution</b> <b>Caution!</b> This danger note draws attention to a potentially dangerous situation that may lead to minor or slight injuries if the safety measures are not followed.
	<b>Note</b> This advice draws attention to potential damage to property or to a process of particular interest / importance that may occur if the safety measures are not followed.

# 1. Introduction

## 1.2 Information for the owner

In addition to these operating and installation instructions and the accident prevention regulations in force in the country of use or at the place of application, it is also necessary to follow the recognised code of safe and proper working practice.

Without the manufacturer's consent, the owner of the lifting column system must not make any changes, additions or modifications to it that may affect safety.

Components used must meet the technical requirements defined by the manufacturer.

Only ever deploy trained or instructed personnel and clearly define personnel responsibilities with regard to operating, servicing and repair.



### Note

Always perform a hazard analysis of your finished product (height adjustable workstation) so you are able to respond to potential residual hazards (e.g. in the form of structural measures or warnings in the operating instructions and/or safety warnings on your product).

Always perform a hazard analysis on your end product (height adjustable workstation) so you are able to respond to potential residual hazards (e.g. by implementing structural measures or providing warnings in the operating instructions and/or safety warnings on your product).

# 2. General

## 2.1 Intended use

	<b>Warning</b>
	<b>Warning!</b> This danger note draws attention to a potentially dangerous situation that may lead to death or serious injuries if the safety measures are not followed.

This lifting column system is only intended for installing and then being used as an electrically height adjustable sitting / standing workstation in accordance with EN 527 in indoor commercial environments. This means the lifting column system is only intended for this purpose.

Any other use beyond this, e.g. outside the technical specifications (see Section 4.1), is deemed to be incorrect use.

	<b>Note</b>
	Do not use the lifting column system in a private environment but only in commercial premises.

In this context, always follow Section 3 "Safety".

Intended use also includes following the operating, servicing and maintenance conditions prescribed by the manufacturer.

Unauthorised changes to the lifting column system will result in the loss of product liability and liability on the part of the manufacturer for resultant damage.

Any other use beyond this is deemed to be non-intended use. The manufacturer shall not be liable for any damage this causes, with the risk involved being borne solely by the user.

## 2.2 Foreseeable incorrect use

	<b>Warning</b>
	<b>Hazards may occur if the system is used incorrectly!</b>  The following situations in particular are deemed to be foreseeable hazardous situations: <ul style="list-style-type: none"><li>• Persons may manipulate protective guards.</li><li>• Persons may remove separating protective guards and then put the lifting column system into operation.</li><li>• Persons may use the desk support in private environments.</li><li>• Persons may use the desk support for lifting persons or loads.</li><li>• Persons could incorrectly install the LegaDrive Eco lifting column and use it in pull direction.</li><li>• Persons may perform servicing or troubleshooting work etc. on the desk support without disconnecting the lifting column system from the power supply.</li><li>• Persons may make adjustments to the desk support despite the presence of other persons in the hazard zone.</li><li>• Persons may ignore the desk support's maximum loading capacity.</li><li>• Persons may open, remove or damage enclosures of system components.</li><li>• Persons may place objects in the desk support travel zone - any collisions may result in damage to the lifting column system.</li></ul>

The situations above describe some of the residual hazards which, despite being impermissible, may occur and harm the health of staff.

The owner must observe the safety requirements defined in the German Ordinance on Industrial Safety and Health (Betriebssicherheitsverordnung).

## 2. General

### 2.3 Package contents

Depending on requirements, the following components may be used for installing an electrically height adjustable workstation.

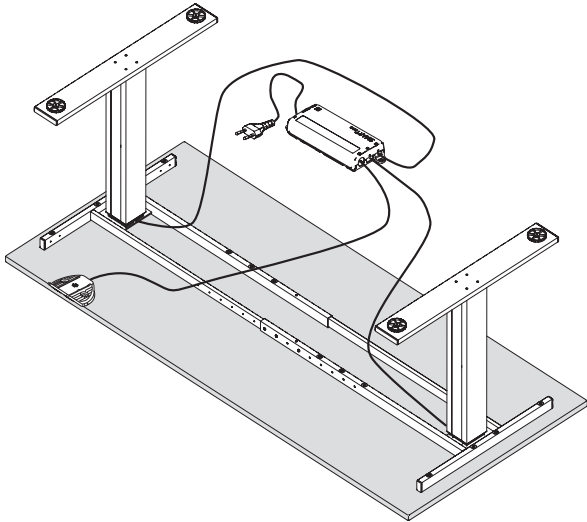

Fig. 1: Example showing overall product

The following components (including cabling) are available for the system:



Fig. 2: Lifting column (here: moved in and out)



Fig. 3: Example of a handset and a control unit



#### Note

Further variants can be found in the Hettich catalogue

If used, the following components are part of the overall system:

Component	Description
Lifting column LegaDrive Eco Q 90 A	LegaDrive Eco power-assisted lifting column. Square 90 mm x 90 mm. Anodised aluminium.
Control unit LegaDrive Eco Smartneo-2-EU	Smartneo-2-EU control unit for LegaDrive Eco. For 2 LegaDrive Eco lifting columns and mains voltage 230V/50Hz.
Control unit LegaDrive Eco Smartneo-2-US	Smartneo-2-US control unit for LegaDrive Eco. For 2 LegaDrive Eco lifting columns and mains voltage 120V/60Hz.
Handset LegaDrive Basic	Handset Basic for LegaDrive. With up and down buttons. Installation under desk top.
Handset LegaDrive Touch Basic	Handset Touch Basic for LegaDrive. With up and down buttons. Installation under desk top.
Handset LegaDrive Touch Basic Inlay	Handset Touch Basic Inlay for LegaDrive. With up and down buttons. Recessed in desk top.
Handset LegaDrive Touch Inlay	Handset Touch Inlay for LegaDrive. With up and down buttons and memory function. With digital display for height setting. Recessed in desk top.
Handset LegaDrive Touch Comfort	Handset Touch Comfort for LegaDrive. With up and down buttons and memory function. With digital display for height setting. Installation under desk top.
Power supply cable LegaDrive Eco EU	Power supply cable for LegaDrive Eco type C. European plug
Power supply cable LegaDrive Eco UK	Power supply cable for LegaDrive Eco type G. Mainly used in the United Kingdom.
Power supply cable LegaDrive Eco NA	Power supply cable for LegaDrive Eco type B. Mainly used in the USA, Canada, Mexico etc.



## 2. General

### 2.4 Liability

Defects must only be rectified by competent personnel.

The manufacturer's liability is restricted to damage caused while using the system in the intended manner. The manufacturer shall not be liable for safety defects not yet identifiable on the basis of the current state of the art.





#### Failure to observe

- safety advice for operating personnel
- advice on particular hazards
- the ban on unauthorised modifications and changes
- ban on using components not approved by the manufacturer



shall rule out any liability on the part of the manufacturer for the consequences.

# 3. Safety

The following hazard zone markings are used in the operating and installation instructions (in accordance with Technical Rule for Working Places ASR A1.3):

	<p><b>⚠ Danger</b></p> <p><b>Danger from electric shock!</b> Working on live components in the improper manner presents a danger to life! Work on electrical equipment must only be carried out by authorised electricians!</p>
	<p><b>⚠ Warning</b></p> <p><b>Risk of injury!</b> The lifting columns pose a risk of injury when they are moving. Before attempting any work, disconnect the lifting column system from power supply and take action to prevent the power supply cable from being plugged back in unintentionally!</p>
	<p><b>⚠ Caution</b></p> <p><b>Tripping hazard!</b> The desk support and power supply cable pose of risk of injury from tripping over.</p>
	<p><b>⚠ Caution</b></p> <p><b>Hand injuries!</b> Hand could be crushed or otherwise injured. Never reach into moving parts! Only set the desk support in motion when there is nobody in the hazard zone!</p>



The following hazard markings must be affixed directly to the desk where they are visible:

	<p><b>⚠ Warning</b></p> <p><b>Danger of crushing!</b> Do not position any objects or parts of the body below the desk support or between the cross members. Failure to observe this warning may result in serious injuries or death!</p>
	<p><b>⚠ Warning</b></p> <p><b>Danger of crushing!</b> Do not overload! Only load the desk support up to the maximum intended load. Overloading may result in breakage and serious injuries!</p>

# 3. Safety

## 3.1 Safety advice for the user company

All persons entrusted with operating the lifting column system LegaDrive Eco (include line managers) must familiarise themselves with the section on "Safety". The safety advice must be followed.

	 <b>Warning</b>
	<p><b>Never</b></p> <ul style="list-style-type: none"><li>• operate the desk support if there is anyone in the hazard zone.</li><li>• operate the desk support in a private environment.</li><li>• remove covers or enclosures and take protective guards out of operation.</li><li>• continue operating the desk support if changes occur that adversely affect safety.</li><li>• manipulate or circumvent protective guards</li><li>• use for normal operation without protective guards in place.</li></ul>

The lifting column system LegaDrive Eco must only be operated if it is in proper working order. The user company will issue clear responsibilities, e.g. for servicing, cleaning or repair, and ensure that the persons carrying out this type of work have received the training necessary for it.

The safety regulations and employers' liability insurance association regulations applicable in the owner's country must also be observed. Refrain from any work that adversely affects operating safety.

The operating personnel will check the desk support for changes or malfunctions, report such to the safety officer responsible and, if necessary, take this product out of operation.

Only appropriate tools must be used for the work that needs to be done; remove tools after completing work.

## 3.2 Safety advice for operating personnel

The desk support must only be put into operation in a fully installed and operational state.

The generally recognised code of occupational health and safety as well as accident prevention regulations must be observed.

The desk support must only be operated if all protective guards and safety-related equipment, e.g. protective claddings or enclosures, are in working order and undamaged.

On putting the system into operation, the operator must make sure that all safety equipment and protective guards as well as the controls are in correct working order and free of damage.

Work on the desk support must only be carried out by instructed, skilled personnel. Only skilled personnel who have received training or instruction must be deployed.

Immediately leave the area around the desk if it starts moving unintentionally. Immediately disconnect the lifting column system LegaDrive Eco from the power supply. Have the desk support repaired by a specialised company. Only put the desk support back into operation after it has been repaired.

Immediately take the desk support out of operation if you notice anything unusual (noises, fumes, smoke etc.) at the desk support. Immediately disconnect the lifting column system LegaDrive Eco from the power supply. Have the desk support repaired by a specialised company. Only put the desk support back into operation after it has been repaired.

Immediately take the desk support out of operation if the safety devices (e.g. up/down switch) are not working properly.

Only operate the desk support in a commercial environment.

Do not use the desk support on an uneven standing surface. It could tip over.

# 3. Safety

Observe the lifting column system's ON time of 10 %. This means, for example, that 1 minute of continuous operation must be followed by a pause of 9 minutes or that operation for a maximum of 2 minutes must be followed by an 18 minute pause.

No not load the desk support beyond the permissible weight limit (see "Technical Specifications" in Section 4.1).

Allow a distance of at least 25 mm for adjacent elements moving in relation to each other. This applies to the entire range of travel.

## 3.3 Safety advice for maintenance work

Please make sure that the product is always in perfect condition and, if necessary, have it checked at regular intervals by skilled personnel.

Do not perform any repairs to the desk or components yourself. Maintenance work must only be performed by the manufacturer's skilled personnel or under the manufacturer's supervision.

If the lifting column system is completely shut down for servicing and repair work, it must be prevented from switching back on unexpectedly.

For maintenance measures use tools that are appropriate for the work involved.

Servicing and repair work must only be carried out by the owner's skilled personnel.

Work on electrical components must only be carried out by a qualified electrician or by instructed persons under the direction and supervision of a qualified electrician in accordance with the rules of electrical engineering.

If safety devices need removing for servicing and repair work, they must be refitted and checked as soon the work has been completed.

Always tighten screw connections that have come loose during servicing and repair work.

Do not make any structural changes to the lifting column system.

Observe the lifting column system's maximum ON time.

Only replace faulty components with new, genuine parts from the manufacturer. When doing so, follow these operating and installation instructions.

Make sure operating consumables and auxiliary substances as well as replaced parts are disposed of safely and in an environment-friendly manner.

## 3.4 Noise

The lifting column system's A-weighted equivalent continuous sound level is less than 60 dB (A).

## 3.5 Hazards from electrical energy

Only connect the lifting column system to the power supply after it has been completely installed.

Regularly check the desk support's electrical equipment in accordance with national regulations (in Germany, the regulations on preventing accidents).

No not use any cable with damaged insulation. You could get an electric shock. Immediately instruct a specialised company to replace damaged cables with undamaged ones.

Do not route the power supply cables near sources of heat. Exposure to heat could damage the cable. A fire could be started or you could get an electric shock.

Disconnect the lifting column system from the power supply if it is to be left unused for a prolonged period or when it is not in use.

# 3. Safety

## 3.6 Particular hazard spots

When adjusting the desk support, make sure there is nobody in the vicinity. They could be injured.

When setting up the desk support, make sure it is unable to collide with anything (e.g. sloping roofs, structural situation, mobile pedestals, wastepaper baskets etc.) in any position to which it can be moved.

Also make sure it cannot collide with objects (e.g. IT equipment) on the desk either.

Allow a safety distance at the side of at least 25 mm to any other item of furniture.





Make sure that cables employed are of sufficient length for safe use throughout the entire range of travel.

## 3.7 Residual risk

The lifting column system reflects the state of the art and is built in accordance with recognised safety regulations. All the same, the user or third parties may still be exposed to hazards.

It must only be used:

- for the intended purpose and
- in an absolutely safe state.

	<b>Warning</b> <b>Risk of injury!</b> Never remove safety devices or render them ineffective by making changes to the desk support! Malfunctions presenting a safety risk must be rectified without delay! Before attempting any servicing and cleaning work, switch the lifting column system off and prevent it from switching back on again!
	<b>Caution</b> <b>Residual hazards!</b> Handling the lifting column system involves residual hazards that could not be limited by design measures. Pay attention to the residual hazards described in these operating and installation instructions as well as in the end product's documentation!
	<b>Note</b> Always perform a hazard analysis of your finished product (height adjustable workstation) so you are able to respond to potential residual hazards (e.g. in the form of structural measures or warnings in the operating instructions and/or safety warnings on your product).
	<b>Warning</b> <b>Risk of injury!</b> Make sure that no unauthorised persons (e.g. small children, persons under the influence of medication etc.) play with or handle your product and the lifting column system.

# 3. Safety

## 3.8 Training/instruction

As owner, you are obliged to inform and instruct the operating personnel in respect of applicable legal and accident prevention regulations as well as the safety devices fitted. In this context, bear in mind the varying specialised qualifications of your staff.

## 3.9 Personnel qualification

Only persons over the age of 16 are allowed to set up and work on the desk support.

The fitters must have read and understood the operating and installation instructions.

Persons	Specially trained personnel	Instructed operating personnel	Instructed persons with specialised training (mechanical / electrical engineering)
Activity			
Handling	X		
Start-up	X		
Setting up, setting	X		X
Operation		X	
Servicing			X
Troubleshooting	X		X
Destruction/ recycling	X		

# 4. Description of the product

## 4.1 Technical specifications

Designation:	Lifting column system for an electrically height adjustable workstation
Type:	LegaDrive Eco
Place of installation:	Indoors (commercial)
Power supply:	230 V; 50 Hz / 120 V; 60 Hz (depending on the control unit used)
Minimum height:	approx. 627 mm
Maximum height:	approx. 1127 mm
max. Loading capacity per column:	- 70 kg, dynamic - Must not be exposed to tensile load!
Desk use:	for 2 columns, dynamic load of 100 kg,
Number of lifting columns for Smartneo-2 control unit:	2 columns
Max. speed:	38 mm/s
Usage cycle:	10 % (2 min. of continuous operation / 18 min. out of operation)
Ambient temperature during operation:	5 °C to 40 °C
Storage / transportation temperature:	-40 °C to 70 °C
Air humidity during operation (non condensing):	5 % to 85 %
Max. noise level:	60 dB (A)
Protection class:	IP 20

Unauthorised changes and modifications to the lifting column system are not permitted for safety reasons and rule out any liability on the part of the manufacturer for any resultant damage.

## 4.2 Controls

The lifting column system's controls are described below.

### 4.2.1 Power supply cable

Depending on place of use, the power supply cables are available in different versions.



#### Note

Please pay attention to the information under "Package contents".



#### Danger

##### Danger from electric shock!

Working on live components in the improper manner presents a danger to life!  
Work on electrical equipment must only be carried out by authorised electricians!



Fig. 4: Various power supply cables

# 4. Description of the product

## 4.2.2 Control unit

Depending on the number of lifting columns needed and the desired mains voltage, the control units are available in different versions.

	<b>Note</b> Please pay attention to the information under "Package contents".
---	--



Fig. 5: Smartneo-2 control unit EU / US

## 4.2.3 Handset

The handset is used for controlling the lifting column system. Depending on the scope of functions, the handsets are available in different versions.

	<b>Note</b> Please pay attention to the information under "Package contents".
---	--



Fig. 6: LegaDrive Basic handset



Fig. 7: LegaDrive Touch Basic handset



Fig. 8: LegaDrive Touch Basic Inlay handset



Fig. 9: LegaDrive Touch Inlay handset



# 4. Description of the product



Fig. 10: LegaDrive Touch Comfort handset

Wireless handsets:



Fig. 11: Wireless handset Basic



Fig. 12: Receiver module for wireless handsets

	<b>Note</b>
	Wireless handsets must be firmly attached and used within sight of the furniture.

	<b>Note</b>
	Refer to the following sections for a detailed description of the functions.

## 4.3 Protective guards

	<b>Note</b>
	The primary safety function during height adjustment is the dead man's principle with momentary contact switch.

### 4.3.1 Mechanical protective guards

Separating protective guards are installed on the lifting column to protect the operator from mechanical hazards. And insulating enclosures are installed around the system's electrical components to protect the operator from electrical hazards.





Fig. 13: Lifting column protective enclosure

	<b>Warning</b>
	<b>Risk of injury!</b> The end product may present further, previously unforeseeable hazards.

# 4. Description of the product

## 4.3.2 Software related protective guards

	 <b>Warning</b>
	<p><b>Risk of injury!</b></p> <p>Despite a number of software based protective guards there is still a risk of getting crushed in exceptional cases as motor shutdown is not only governed by the control unit but also by the interaction of the mechanical and electronic components! Shutdown sensitivity is also influenced by the mechanical components, motor and ambient conditions!</p> <p>For this reason, the manufacturer cannot entirely rule out this residual risk and does not accept any liability!</p>

The control unit contains the following software related protective guards:

- Collision detector ISP (Intelligent System Protection) with automatic Drive Back functionality (see Section 7.5.7)
- Low speed areas
- ON time monitor
- Safety zone
- Pedestal stop and shelf stop position
- Plug detection

	<b>Note</b>
	You will find a detailed description of how to use the listed functions in the following sections.



# 5. Transportation and installation



## 5.1 Transportation

Only move the lifting column / desk support in a dead state (disconnect power supply cable from power supply).



During installation

- electrical work must be performed by qualified electricians,
- mechanical work must be performed by appropriately skilled persons.

	 <b>Warning</b>
	<b>Warning!</b> You could get knocked and crushed while lifting and transporting the lifting column / desk support!

	 <b>Warning</b>
	<b>Warning!</b> While transporting the desk support no persons or objects must be on the desk or hanging from it.

## 5.2 Installation

	 <b>Danger</b>
	<b>Danger to life from electric current!</b> The enclosures around the LegaDrive Eco's components must not be opened, removed or damaged. The power supply cable must be unplugged from the power supply while installing the control unit!

# 5. Transportation and installation

## 5.2.1 Installing lifting column

Fit the lifting column to the foot extension and desk top support.

To do this you will need the following tools:

- 1 x hex driver,
- 8 x M6 hexagon socket head screws per lifting column.

	<b>Note</b>
	Use M6 screws of appropriate length, paying attention to maximum screw length. The screw must be driven into the column by 8 - 12 mm.

To install the lifting column proceed as follows:

1. Connect a foot extension to a lifting column by means of four hexagon socket head screws.

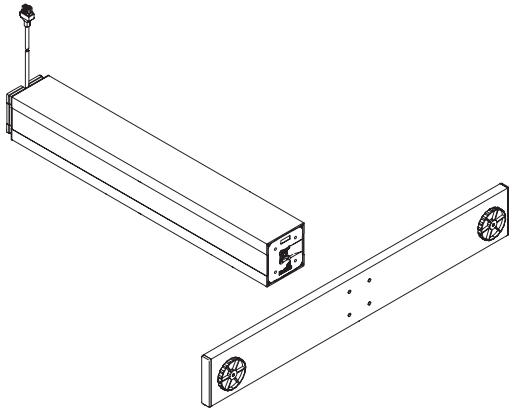

Fig. 14: Attaching lifting column (viewed from below) to example foot extension

2. Now tighten the four screws on each lifting column to 7 Nm max. using a hex driver.
3. Now connect the requisite lifting columns to the desk top support by means of four hexagon socket head screws per lifting column.

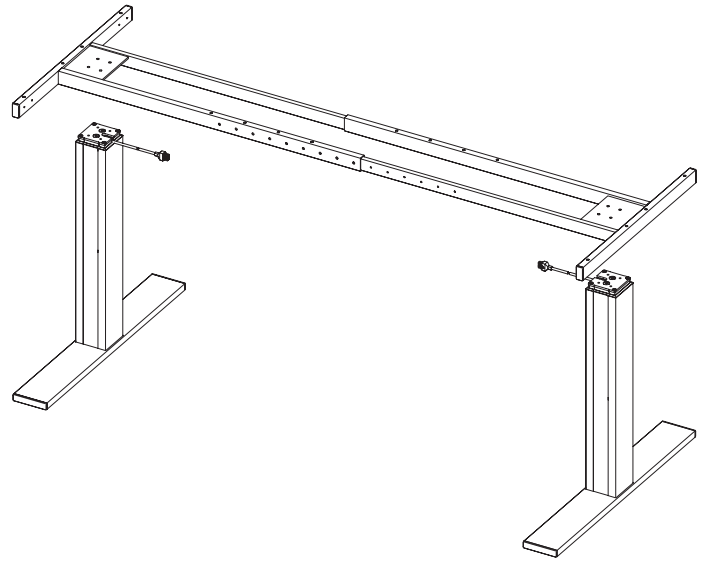



Fig. 15: Attaching lifting column (viewed from above) to example desk top support

4. Now tighten the four screws on each lifting column to 7 Nm max. using a hex driver.
5. The desk top can now be fitted.

	<b>Note</b>
	An even standing surface with a sufficient load bearing capacity is essential for setting up the height adjustable desk in a proper and safe manner. Any unevenness in the standing surface must be evened out.

	<b>Note</b>
	If lifting columns are replaced in a system, it is imperative to return the lifting columns to factory settings first (see Section 7.5.10) and perform a manual reset (see Section 7.4.4).

# 5. Transportation and installation

## 5.2.2 Installing control unit

	<b>Note</b>
	Be sure to check that the controller is suited for the LegaDrive Eco lifting column before assembling the product. Refer to the specifications on the type plates. Observe the mains voltage.

Install the control unit underneath the desk top. To do this you will need the following tools:

- 1 x screwdriver
- 1 x pencil,
- 1 x drill with drill bit (for predrilling).

To install the control unit proceed as follows:

1. Position control unit at chosen position on desk top,
2. Mark drill holes with pencil.

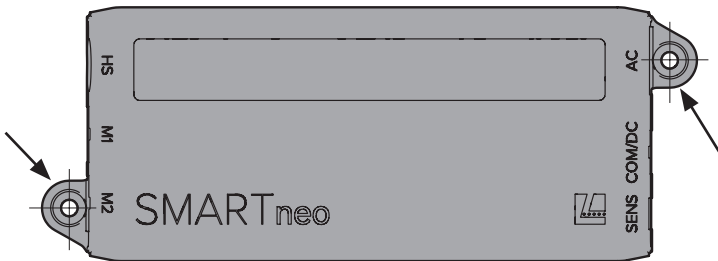



Fig. 16: Fixing points on control unit

3. Predrill these two drilling points.
4. Attach control unit at predrilled points using two screws.

	<b>Note</b>
	The manufacturer recommends panhead screws DIN 7981 C 4.8 x L with a panhead diameter of 9.5 mm. The length of screw must be appropriate for the table top's thickness. Tightening torque will depend on the table top material but should not exceed 2 Nm.

## 5.2.3 Installing handset

Depending on the handset used, follow the installation instructions below:

	<b>Note</b>
	The position of the handset must be selected so that no damage can occur during operation.

### 5.2.3.1 Installing LegaDrive Basic handset



Fig. 17: LegaDrive Basic handset

Install the handset under the desk top. To do this you will need the following tools:

- 1 x screwdriver
- 2 - 4 x screws (depending on the type of handset)

To install the LegaDrive Basic handset under the desk top, proceed as follows:

1. Unpack handset.

	<b>Note</b>
	Dispose of the packaging material in an environmentally friendly manner (plastic film with plastic waste, cardboard with paper waste)!

2. Position handset at chosen position under desk top, making sure that the handset is in easy and convenient reach.
3. Attach the handset with 2 screws.

	<b>Note</b>
	The following screw types must be used for attaching the LegaDrive Basic handset: - cylinder head screws - roundhead screws - panhead screws Maximum thread diameter: 5 mm Maximum head diameter: 9 mm

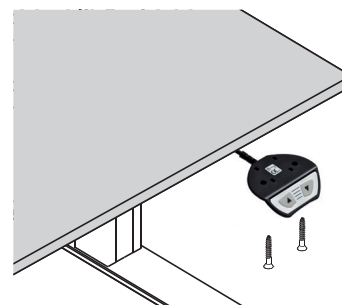

Fig. 19: Attaching LegaDrive Basic handset to example desk

# 5. Transportation and installation

## 5.2.3.2 Installing LegaDrive Touch Basic handset



Fig. 19: LegaDrive Touch Basic handset

Install the handset under the desk top. To do this you will need the following tools:

- 1 x screwdriver
- 2 x screws

To install the LegaDrive Touch Basic under the desk top, proceed as follows:

1. Unpack handset.

	<b>Note</b>
	Dispose of the packaging material in an environmentally friendly manner (plastic film with plastic waste, cardboard with paper waste)!

2. Position handset at chosen position under desk top, making sure that the handset is in easy and convenient reach.
3. Attach the handset with 2 screws.

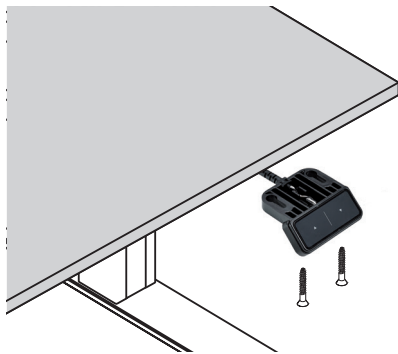



Fig. 20: Attaching LegaDrive Touch Basic handset to example desk

	<b>Note</b>
	The following screw types must be used for attaching the LegaDrive Touch Basic handset: - cylinder head screws - roundhead screws - panhead screws Maximum thread diameter: 4 mm Maximum head diameter: 7.3 mm

## 5.2.3.3 Installing LegaDrive Touch Basic Inlay handset



Fig. 21: LegaDrive Touch Basic Inlay handset

Install the handset at an appropriate position in the desk top.

	<b>Warning</b>
	Do not set any objects down on inlay handsets. This may unintentionally actuate the handset and move the desk.

To install the LegaDrive Touch Basic Inlay handset under the desk top, proceed as follows:

1. Unpack handset.

	<b>Note</b>
	Dispose of the packaging material in an environmentally friendly manner (plastic film with plastic waste, cardboard with paper waste)!

2. Drill / cut out an installation hole. The cut out is illustrated below.

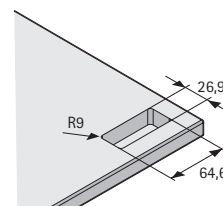

Fig. 22: Cut out for installing LegaDrive Touch Basic Inlay handset with rubber fins

3. Insert the handset from above into the previously drilled hole in the desk top. The handset is installed without additional screws, the rubber fins hold it in position.

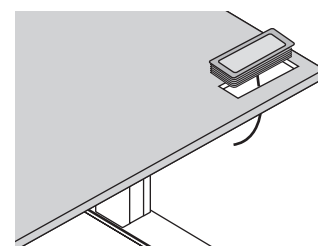

Fig. 23: Attaching LegaDrive Touch Basic Inlay handset to example desk

# 5. Transportation and installation

## 5.2.3.4 Installing LegaDrive Touch Inlay handset



Fig. 24: LegaDrive Touch Inlay handset

Install the handset at an appropriate position in the desk top.

	<b>! Warnung</b>
	Do not set any objects down on inlay handsets. This may unintentionally actuate the handset and move the desk.

To install the LegaDrive Touch Inlay handset under the desk top, proceed as follows:

1. Unpack handset.

	<b>Note</b>
	Dispose of the packaging material in an environmentally friendly manner (plastic film with plastic waste, cardboard with paper waste)!

2. Drill / cut out an installation hole. The cut out is illustrated below.

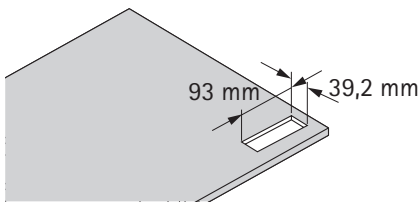

Fig. 25: Cut out for installing LegaDrive Touch Inlay handset with rubber fins

3. Insert the handset from above into the previously drilled hole in the desk top. The handset is installed without additional screws, the rubber fins hold it in position.

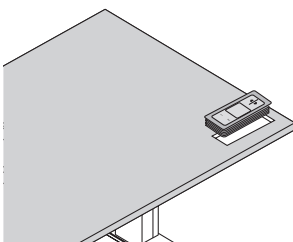

Fig. 26: Attaching LegaDrive Touch Inlay handset to example desk

## 5.2.3.5 Installing LegaDrive Touch Comfort handset



Fig. 27: LegaDrive Touch Comfort handset

Install the handset at an appropriate position underneath the desk top. To do this you will need the following tools:

- 1 x screwdriver
- 4 x screws

	<b>Note</b>
	Please note that the handset has a Push to open function. Install the handset in the extended position to make all screw holes accessible.

To install the LegaDrive Touch Comfort handset under the desk top, proceed as follows:

1. Unpack handset.

	<b>Note</b>
	Dispose of the packaging material in an environmentally friendly manner (plastic film with plastic waste, cardboard with paper waste)!

2. Position handset at chosen position under desk top, making sure that the handset is in easy and convenient reach. The front edge of the handset should not project beyond the edge of the desk so as not to get in the way when you are working.

# 5. Transportation and installation

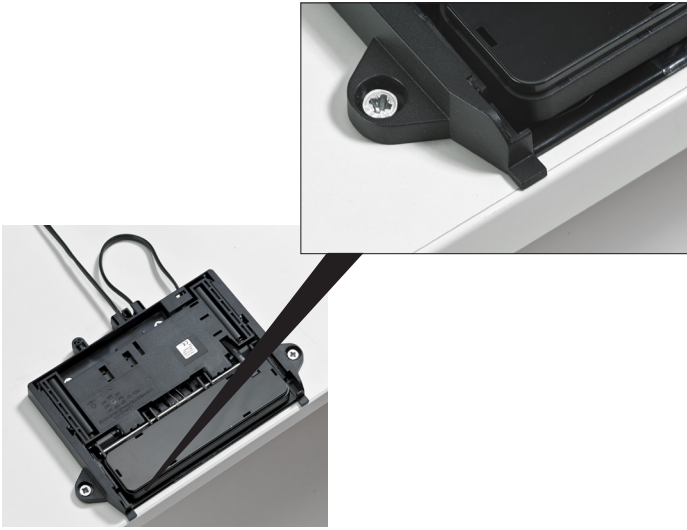

Fig. 28: Position for installing LegaDrive Touch Comfort handset

3. Attach the handset with 4 screws. To do this, use all 4 screw holes shown below.

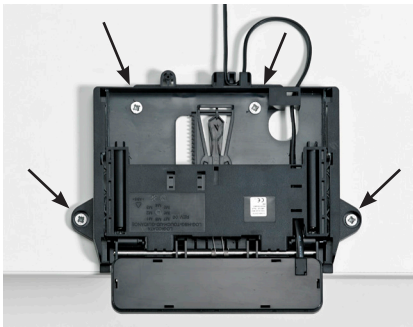

Fig. 29: Position of screw holes for installing LegaDrive Touch Comfort handset.



### Note

The following screw types must be used for attaching the LegaDrive Basic handset:

- cylinder head screws
- roundhead screws
- panhead screws

Maximum thread diameter: 5 mm

Maximum head diameter: 10 mm

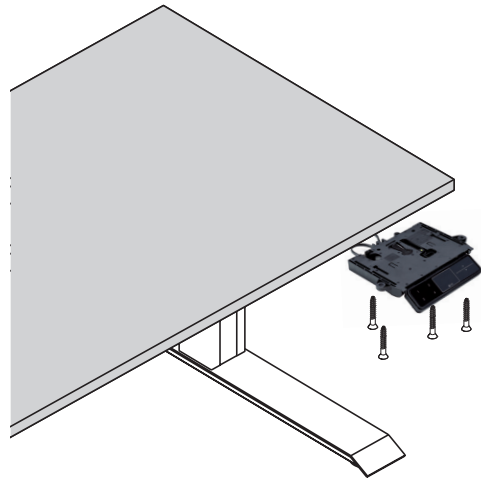

Fig. 30: Attaching LegaDrive Touch Comfort handset to example desk



### Note

The manufacturer recommends predrilling the 4 screw holes in the desk top. This stops the mounting plate from twisting when screwing down the handset and making it difficult for the control panel to move in and out or even preventing it from doing so.



# 5. Transportation and installation

## 5.2.3.5.1 Notes on the push-to-open feature

The LegaDrive Touch Comfort manual switch has a push-to-open feature which automatically extends the control panel when it is pushed.



	<b>Note</b>
	To automatically extend the control panel (push-to-open feature), it must be pushed in the retracted position and then released. When retracted the control panel must not be pulled out to avoid the manual switch from being damaged!



Fig. 31: Pressing the control panel to automatically extend it



Fig. 32: Lifting and pushing the control panel to retract it

	<b>Note</b>
	The connecting cable must form a loop of at least 10 cm to ensure proper operation of the push-to-open feature (see figure 33).

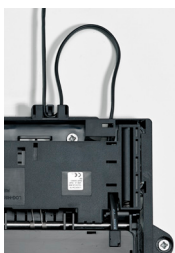

Fig. 33: Cable loop of 10 cm min. for the push-to-open feature

## 5.2.3.5.2 Notes on the control panel

To prevent damage, the control panel is designed so that it detaches from its anchorage under unusually high pressure (forces applied from above).



Fig. 34: Control panel detached from above from its anchorage

Follow the steps described below to re-connect the control panel with the moveable slide:

1. Push the spring ends into the slide seat.

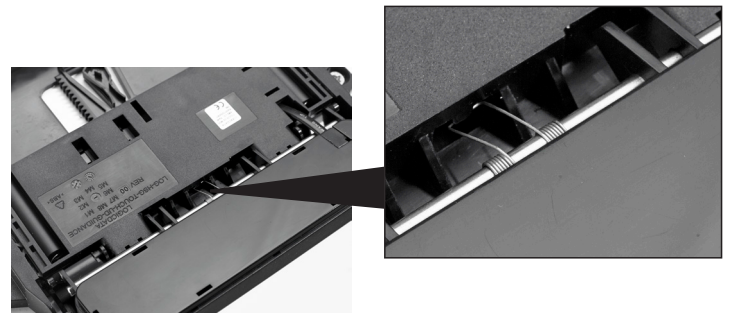

Fig. 35: Spring end hooked into the lug below the slide

2. Push the control panel into the slide by pressing the marked positions.

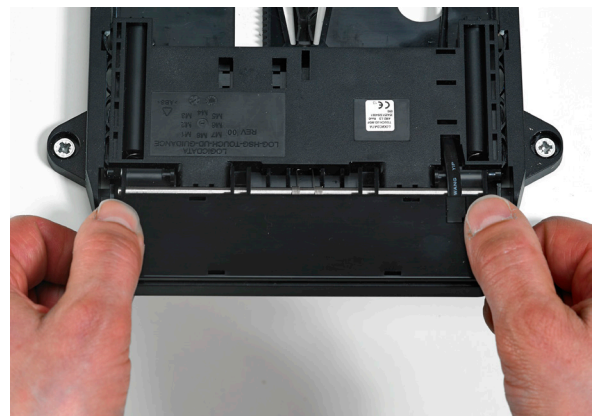

Fig. 36: Pushing the control panel into the slide

# 5. Transportation and installation

## 5.2.3.6 Installing the wireless handset Basic

	<b>Note</b>
	Do not install the wireless handset Basic unless the remote receiver has been programmed (see 6.2.4).



Fig. 38. Wireless handset Basic

Install the wireless handset Basic under the desk top. The following tools are required for the installation:

- 1 x screw driver,
- 2 screws,

Follow the steps described below to install the wireless handset Basic:

1. Unpack the handset.

	<b>Note</b>
	Dispose of the packing material in an environmentally responsible manner (plastic foil in the plastic waste container, cardboard in the container for waste paper)!

2. Insert the battery into the handset.
  - a) To do so, you have to remove the battery cover of the handset.
  - b) Then insert the button cell (CR 2032, included). Observe the correct battery polarity.
  - c) Replace the battery cover on the handset.

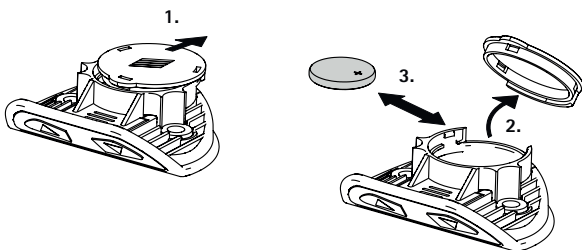



Fig. 38: Inserting / replacing the battery Button cell CR 2032

3. Place the handset in the required position on the piece of furniture. Make sure that the handset is easily and conveniently accessible.
4. Attach the handset using two screws.

	<b>Note</b>
	The following screw types should be used for attaching the wireless handset Basic:
	- Cylinder head screws - Round-head screws - Flat-head screws
	Max. thread diameter: 4.5 mm Max. head diameter: 8 mm

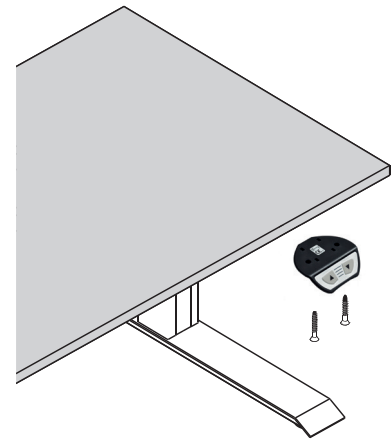



Fig. 39: Installing the wireless handset Basic

	<b>Note</b>
	The wireless handset Basic must be firmly attached and used within sight of the furniture.



# 6. Start-up



Startup includes those activities that are involved in using the lifting column system LegaDrive Eco to adjust the height of an electrically height-adjustable workstation. Before the system can be started up, the following items must have been installed:



- the control unit,
- the lifting columns for adjusting the height of the desk top,
- the handset
- Section 6.1 of these operating instructions must be observed during the initial start-up.

Servicing and maintenance work in specific disciplines (electrical engineering etc.) must only be carried out by skilled persons trained in that particular discipline.

Observe the following safety advice!

	 <b>Danger</b>
	<p><b>Danger to life!</b> Working on live components in the improper manner presents a danger to life! Work on the electrical equipment must only be carried out by authorised electricians. The lifting column system LegaDrive Eco must be disconnected from the power supply before carrying out repair and cleaning work! Disconnect the power supply cable from mains power supply and take action to prevent it from being plugged back in unintentionally.</p>

	 <b>Warning</b>
	<p><b>Warning!</b> The enclosures around the LegaDrive components must not be opened, removed or damaged.</p>

	 <b>Warning</b>
	<p><b>Warning!</b> You could get crushed by moving parts if the lifting column is not shut down. The lifting column system LegaDrive Eco must be disconnected from the power supply before carrying out maintenance and cleaning work! Disconnect the power supply cable from mains power supply and take action to prevent it from being plugged back in unintentionally.</p>

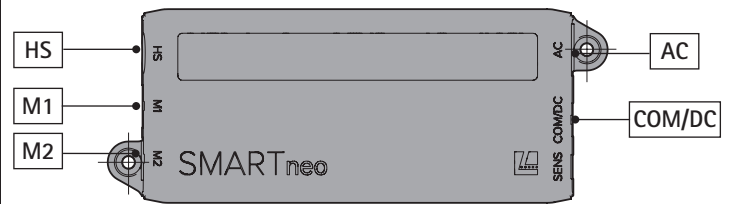





Fig. 40: Sockets on control unit

- 6-pin Minifit for cascading cable (COM/DC)
- 2-pin C7 for power supply (AC)
- DIN for handset (HS)
- 8-pin Minifit for actuators (M1, M2)

	Hinweis
	<p>On unpacking, ensure ESD compliant handling. Faults resulting from electrostatic discharge are not covered by the warranty.</p>

	Hinweis
	<p>Before installing and starting up the SMARTneo control system, make sure that the product has acclimatised to the values specified in the data sheet for temperature and humidity at the point of application!</p>

	Note
	<p>It is not permissible to plug products you have made yourself into the control unit! Only use manufacturer approved components or the device may be damaged or irreparably broken!</p>

# 6. Start-up

## 6.1 Starting up for the first time

Before starting up the desk support for the first time, observe the following:

- Check to make sure the lifting column system LegaDrive Eco has been installed in accordance with the regulations specified!
- Check the documentation of the manufacturer of the desk, whether it has been properly installed.
- Make sure that the desk is placed on a level surface and aligned horizontally.
- Make sure that moving components can move without obstruction into the spaces they require and that the safety distances are observed!
- Make sure the safety devices are in proper working order!
- When commissioning for the first time, a reference run must be carried out. See chapter 6.4 Reset on starting up for the first time.
- The workplace must be clean, dry and ESD protected.

	<b>Note</b>
	On start-up, listen for unusual noises and check to see if there is any heat buildup on adjusting desk top position.
	If this is the case, take the desk support out of operation. Have the lifting column system LegaDrive Eco repaired by a specialised company and only put the desk support back into operation after it has been repaired.

## 6.2 Start-up procedure

	<b>Danger</b>
	<b>Danger to life!</b>
	Danger to life from electric shock! The power supply cable must only be plugged in once all components are connected to the control unit.
	The power supply cable must be freely accessible at all times so that the drive system can be disconnected from the mains in an emergency!

### 6.2.1 Plugging in drives / lifting columns

Plug the cables of the lifting columns into the appropriate 8-pin motor/lifting column sockets (M1 to M3).

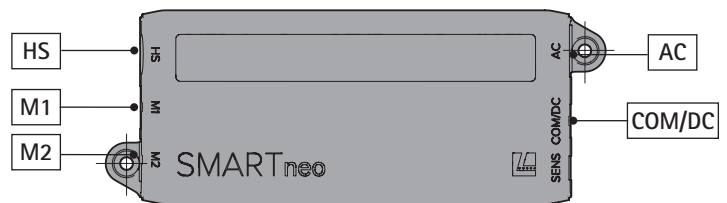



Fig. 41: Sockets on control unit

	<b>Note</b>
	When plugging in the lifting column cables, always keep to the order of sequence of M1, M2, M3 (see Fig. 41)!

# 6. Start-up

## 6.2.2 Plugging in handset / wireless receiver

Plug the handset / wireless receiver cable into the 7-pin socket.

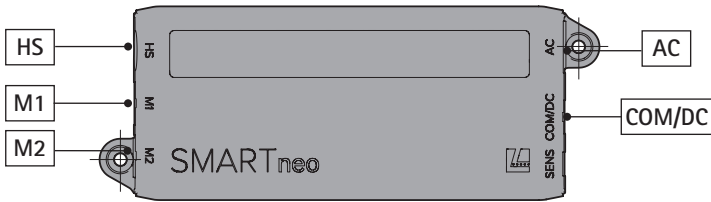

Fig. 42: Sockets on control unit

	<b>Note</b>
	<p>You can choose between several handsets for the control unit.</p> <p>You will find further information on available handsets under "Package contents".</p>

## 6.2.3 Plugging in power supply cable

	<b>Warning!</b>
	<p>Before plugging in the power supply cable (socket P), check once again to make sure that</p> <ul style="list-style-type: none"> <li>· the mains voltage is the same as the mains voltage shown on your control unit's rating plate,</li> <li>· all components are connected to the right sockets,</li> <li>· the earth cable is attached!</li> </ul>

The control unit is ready for operation once the power supply cable has been plugged in.

When installing the power supply, it must be ensured that the control unit can be disconnected from the power supply at any time.

	<b>Note</b>
	<p>A manual reset may be necessary if there is a power cut or if the power supply cable is unplugged while adjusting height (see Section 7.4.4).</p>

	<b>Warning!</b>
	<p>When laying the cables, make sure they are not pinched, kinked or stripped of their insulation. When laying the supply cable, observe the DIN EN 60335-1 (VDE 0700-1).</p>

	<b>Warning!</b>
	<p>When laying the cables make sure that no one can trip over them (e.g. mains connection cable).</p>

	<b>Warning!</b>
	<p>When laying the cables, make sure you allow sufficient cable length for height adjustment.</p>

	<b>Note</b>
	<p>In this context, also follow the rules and regulations usually applied in the industry, such as those collated in the "Guideline - Electrical Installations in Office Furniture", published by buero-forum which belongs to bso Verband Büro, Sitz- und Objektmöbel e.V., the German association for office furniture, seating and contract furniture.</p>

# 6. Start-up

## 6.2.4 Programming the wireless handset

	<b>Hinweis</b>
	Ensure that the wireless receiver is connected to the control unit and the mains connection has been established.

The wireless receiver must be programmed (taught) to be able to understand the radiogram from the wireless handset. The teach-in procedure creates an assignment only in the wireless receiver. The distance between the wireless handset and the wireless receiver should not exceed 0.5 m during the programming.

The wireless receiver has a „Teach-in“ key (A) for programming and a „Control“ LED (B) as an indicator.



Abb. 43: Wireless receiver

### Programming

Follow the steps described below:

1. Briefly press the „Teach-in“ button on the wireless receiver. The „Control“ LED lights up.
2. Immediately send a radio signal (approx. 2 sec.) with the wireless handset. You can press the „up“ or „down“ key to send the signal. The LED switches off briefly.
3. The teach-in procedure automatically ends after approx. 8 s. When the „up“ or „down“ key of the wireless handset is pressed again, the procedure ends immediately.

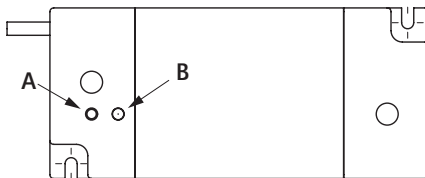
### Logging off

Follow the steps described below:

1. Press the „teach-in“ key at the wireless receiver. The „control“ LED lights up (flashes).
2. Continue to hold the key down until the LED stops flashing. This completely deletes the wireless receiver memory.

## 6.2.4.1 Replacing the battery

The wireless handsets are operated with a lithium button cell (CR 2032 included in delivery).

	<b>Note</b>
	Immediate remove used button cells (batteries) and dispose of them in an environmentally friendly manner. They must not be discarded with household rubbish! Replace button cell with identical type only.

4. Open the battery compartment
5. Remove used button cell
6. Insert new button cell (CR2032)  
Pay attention to polarity and avoid soiling
7. Close battery compartment (click into place)

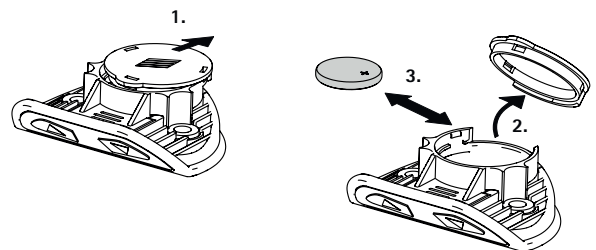

Fig. 44: Battery change

### 6.3 Overall configuration (example)

In the illustration below you can see the socket assignment for an example configuration. This example configuration comprises:

- 1: one LegaDrive Eco Smartneo-2 type control unit.
- 2: one desk support with two LegaDrive Eco lifting columns
- 3: one LegaDrive Basic type handset
- 4: one LegaDrive Eco EU power supply cable.

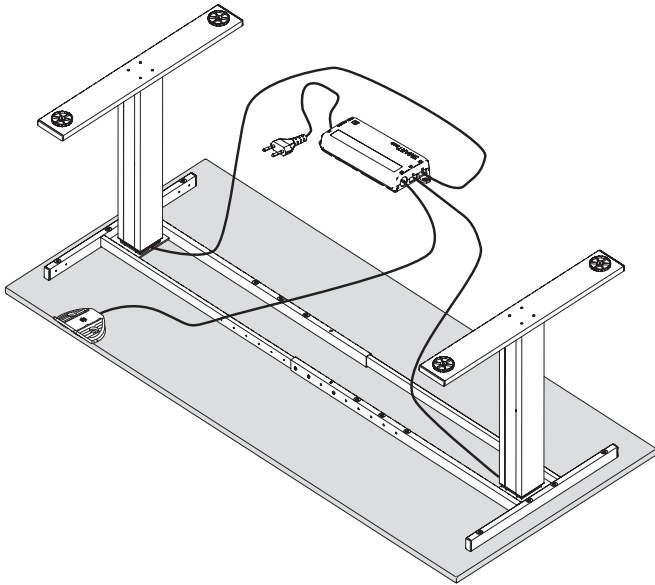

Fig. 45: Example configuration

### 6.4 Reset on starting up for the first time

When starting up for the first time, the product must be reset before it can be put into operation.

Resetting the products moves all columns to the same level. This makes sure that the desktop moves parallel to the base level. In its standard configuration, the control system also memorises the components connected, such as the number of drives.

After resetting, configuration changes will be identified and interpreted as faults. The system remains stationary until the memorised state has been restored.



#### Warning

##### Warning!



During the reference run, no furniture parts (e.g. containers, covers,...) or objects may be within the adjustment range of the desk. It must be ensured that the lifting columns can retract completely. Non-compliance leads to damage to the lifting column system!



#### Warning

##### Warning!

Collision detection (ISP) is not active in any reset cycle or during end position calibration. Please realise that you could get crushed!

No.	Button	Function
1.		Press the <b>desk top down</b> button. Keep the desk top down button pressed until the desk top has reached the lowest position (programmed end position).
2.		Release the <b>desk top down</b> button. The electrically height adjustable workstation can be used in the normal way again.





# 7. Operation

To ensure that the LegaDrive Eco systems operates safely, please observe the following safety advice:

	<b>⚠ Danger</b>
	<b>Danger to life!</b> Danger to life from electric shock! Keep children away from the electrically height adjustable workstation as well as from the motor control unit and handset! They could be injured by voltage.

	<b>⚠ Warning</b>
	<b>Warning!</b> Make sure that the desk support always moves correctly and without jerking. If this is not the case, disconnect the power supply cable from the mains power and kindly contact the manufacturer's customer service department.

	<b>Note</b>
	A manual reset may be necessary if there is a power cut or if the power supply cable is unplugged while adjusting height (see Section 7.4.4).

	<b>Note</b>
	Unplug the power supply cable from the power socket in the event of a thunderstorm or prolonged absence! Otherwise the system suffer might damage from mains related voltage surges.

## 7.1 Basic functions

	<b>Note</b>
	The control unit provides a wide range of functions. The availability of some functions, however, depends on the handset used. This section describes the basic functions that are supported by all handsets intended for the control unit.





# 7. Operation

## 7.1.1 Upward desk top movement

The function provides an easy way of adjusting the desk top to a higher position. To do this, proceed as follows:

	Note
	The desk top will continue to move up until you release the button, or until the highest position is reached.

No.	Button	Function
1.		Press the <b>desk top up</b> button and keep it pressed until the desk top reaches the height you want.

	Note
	To reduce power consumption, the control unit automatically switches to standby mode when not in use. The desk top starts to move with a brief lag if the control unit was in standby mode.

## 7.1.2 Downward desk top movement

The function provides an easy way of adjusting the desk top to a lower position. To do this, proceed as follows:

	Note
	The desk top will continue to move down until you release the button, or until the lowest position is reached.

No.	Button	Function
1.		Press the <b>desk top down</b> button and keep it pressed until the desk top reaches the height you want.

	Note
	To reduce power consumption, the control unit automatically switches to standby mode when not in use. The desk top starts to move with a brief lag if the control unit was in standby mode.

# 7. Operation

## 7.2. Display functions

	<b>Note</b>
You can only use the following control unit functions if you have a handset with a display (such as LegaDrive Touch Inlay or LegaDrive Touch Comfort).	





The LegaDrive Touch handset has a 4-digit display with optional decimal point for showing position and information. This is capable of displaying current desk height, fault messages and menus. The unit in which desk height is displayed and the decimal point settings are determined by the motor control parameters.



Fig. 46: Display on LegaDrive Touch handset

### User interface:

In the description below, the various buttons are depicted as follows:

-  Desk top up
-  Desk top down
-  SAVE button
-  Memory position button 1
-  Memory position button 2
-  Memory position button 3
-  Memory position button 4

## 7.3. Display lock

	<b>Note</b>
You can only use the following control unit functions if you have a handset with touch functionality and display (such as LegaDrive Touch Inlay or LegaDrive Touch Comfort).	

The display lock is activated or deactivated by swiping your finger across the display. The display shows a key symbol on activating the lock.

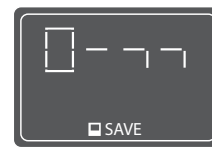



Fig. 47: The key symbol indicates activated display lock





Fig. 48: The LegaDrive Touch Comfort handset lock is activated and deactivated by swiping to the left or right



Fig. 49: The LegaDrive Touch Inlay handset lock is activated and deactivated by swiping to the left or right

	<b>Note</b>
The swiping direction is irrelevant. (see Figures 48 and 49)	

	<b>Note</b>
Be careful only to swipe lightly over the display without pressing any of the buttons.	

	<b>Note</b>
The display must be active at the time of activating / deactivating the lock (e.g. indicating current height). The display can be activated by briefly pressing one of the buttons, e.g. the UP button.	

# 7. Operation







## 7.4 Extended functions

	<b>Note</b>
	<p>You can only use the following control unit functions if you have a handset with <b>memory position buttons</b> and a <b>memory button</b>.</p>

### 7.4.1 Memorising a desk top position

This function memorises a defined desk top height (one desk top height can be memorised per memory position button). To memorise a desk top position, proceed as follows:



	<b>Note</b>
	<p>If the control unit is being switched on for the first time, all memorised positions provide the lowest desk top height (bottom desk top position).</p>

No.	Button	Function
1.	 	<p>Move the desk top to the desk top position you want.</p> <p>The display shows this position (e.g. 73 cm).</p>
2.	 	<p>Press the SAVE-button.</p> <p>The display shows S -.</p>
3.	  	<p>Press the chosen <b>memory position button</b> (e.g. 2).</p> <p>The display shows S 2.</p> <p>The desk top position setting will now be memorised on the memory position button selected. You will hear the control unit click twice and the memorised desk top position will be displayed after approx. 2 seconds.</p>

# 7. Operation

## 7.4.2 Adjusting desk top to a memorised position

This function lets you move the desk top to a memorised desk top position. To move to a memorised desk top position, proceed as follows:







No.	Button	Function
1.		Press the chosen memory position button (e.g. 2) and keep it pressed. The desk top will continue to move until the memorised desk top position is reached. If you let the button go before reaching the memorised desk top position, the desk top will stop and the memorised desk top position will not be reached.
2.	 	Release the memory position button as soon as the memorised desk top position has been reached. The display shows the current (memorised) desk top position.

## 7.4.3 Changing desk top position height display

This function is used for adjusting the height indicated on the handset display to the desk top's actual height. To make this adjustment, proceed as follows:

	<b>Note</b>
	Please note that this setting process does not alter the desk top's position. Only the indication on the display changes.



	<b>Note</b>
	This function is only provided for handsets with integrated display.



No.	Button	Function
1.	 	Press the SAVE-button. The display shows S -.
2.	 	Press the desk top down button for approx. 5 seconds (downwards arrow). The display starts to flash.
3.	 	Now set the height display using the desk top down (downwards arrow) or desk top up button (upwards arrow).
4.		Press the SAVE-button. The height display is now set to the desk top position entered.



# 7. Operation

## 7.4.4 Manual reset

If the actual desk top position no longer matches the desk top position displayed or if a previously configured control unit is used at another electrically height adjustable workstation of identical design, you must calibrate the end position at the bottom most desk top position.

	 <b>Warning</b>
	<p><b>Warning!</b> During the reference run, no furniture parts (e.g. containers, covers,...) or objects may be within the adjustment range of the desk. It must be ensured that the lifting columns can retract completely. Non-compliance leads to damage to the lifting column system!</p>

	 <b>Warning</b>
	<p><b>Warning!</b> Collision detection (ISP) is not active in any reset cycle or during end position calibration. Please realise that you could get crushed!</p>

No.	Button	Function
1.		Press the <b>desk top down</b> button. Keep the desk top down button pressed until the desk top has reached the lowest position (programmed end position).
2.		Press the <b>desk top down</b> button again and continue to keep it pressed. After approx. 5 seconds the desk top will continue to move down until the bottom most desk top position is reached.
3.		Release the <b>desk top down</b> button. The electrically height adjustable workstation can be used in the normal way again.

## 7.5 Software related functions

	<b>Note</b>
	<p>The control unit is parameterised by software before leaving the factory. The following functions can only be used if the control unit is parameterised accordingly.</p>

### 7.5.1 Low speed areas

While desk top height is being adjusted, this function (low speed area) automatically slows down the the speed of movement before the following positions are reached:

- Top and bottom desk top position.
- All memorised positions (e.g. memory position, pedestal stop position).

### 7.5.2 ON time monitor



On reaching a defined ON time, the ON time monitor has the function of shutting down the control unit for a defined period (e.g. the control unit is automatically shut down for 18 minutes after 2 minutes of continuous operation).

# 7. Operation

## 7.5.3 Safety zone

This function produces a safety stop at a defined desk top position (configured by software). The safety stop works as follows:

	<b>Note</b>
Desk top positions in safety zones cannot be memorised.	

No.	Button	Function
1.		Press the <b>desk top down</b> button. Keep the desk top down button pressed until the desk top stops automatically. Desk top movement is stopped above the safety zone.
2.		Press the <b>desk top down</b> button again. Keep this button pressed until the desk top reaches the height you want.

## 7.5.4 Pedestal stop and shelf stop positions

These two features can be used to limit the desk's travelling range (e.g. where a pedestal is standing under the desk). There must be no objects, such as garments or pedestals, present between the desk support and the foot extension. Any resultant collisions may cause damage to the lighting column system. A pedestal stop position can be set in the lower half of the travelling range, a shelf stop position in the upper half. If a pedestal stop position is set, this is used as the new end position; a shelf stop position functions as a new upper end position for the travelling range. To memorise a pedestal stop / shelf stop position, proceed as follows:

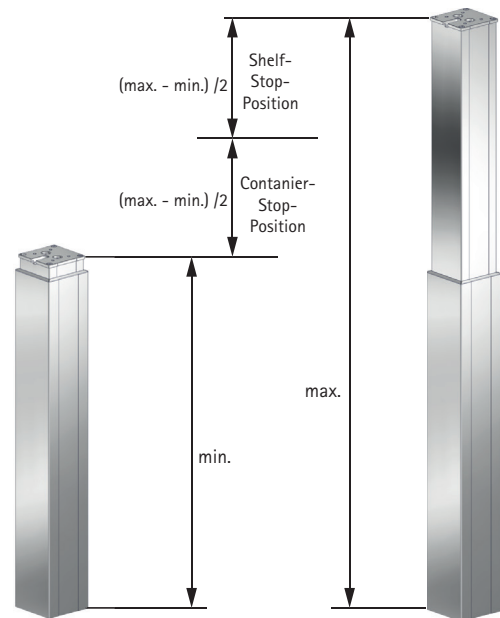









Fig.50: Container-Stop- / Shelf-Stop-Position

	<b>Note</b>
These steps must be performed separately for a pedestal stop position and a shelf stop position.	

# 7. Operation





No.	Button	Function
1.	 or 	Move the desk top to the position you wish to use as the new pedestal stop / shelf stop position. To do this, press the <b>desk position down</b> or <b>desk position up</b> buttons until the chosen position is reached.
2.	 	Simultaneously press the <b>desk position up</b> and <b>desk position down</b> buttons and keep both buttons pressed for approx. 10 seconds. The control unit clicks <b>twice</b> once the position has been memorised.

If you have a handset with display (such as LegaDrive Touch Inlay or LegaDrive Touch Comfort), proceed as follows:



No.	Button	Function
1.	 or 	Move the desk top to the position you wish to use as the new pedestal stop / shelf stop position. To do this, press the <b>desk position down</b> or <b>desk position up</b> buttons until the chosen position is reached.
2.		Press the <b>SAVE</b> -button and keep it pressed for approx. 10 seconds. The control unit clicks <b>twice</b> once the position has been memorised.

To deactivate a pedestal stop / shelf stop position, proceed as follows:

	<b>Note</b>
These steps must be performed separately for a pedestal stop position and a shelf stop position.	

No.	Button	Function
1.	 or 	Move the desk top to any position in the lower half of the travelling range to deactivate the pedestal stop or to any position in the upper half of the travelling range to deactivate the shelf stop. To do this, use the <b>desk position down</b> or <b>desk position up</b> buttons until the chosen position is reached.
2.	 	Simultaneously press the <b>desk position up</b> and <b>desk position down</b> buttons and keep both buttons pressed for approx. 10 seconds. The control unit clicks once when the position has been deactivated.

If you have a handset with display (such as LegaDrive Touch Inlay or LegaDrive Touch Comfort), proceed as follows:

No.	Button	Function
1.	 or 	Move the desk top to any position in the lower half of the travel range to deactivate the container stop or to any position in the upper half of the travel range to deactivate the shelf stop. To do this, use the <b>desk position down</b> or <b>desk position up</b> buttons until the chosen position is reached.
2.		Press the <b>SAVE</b> -button and keep it pressed for approx. 10 seconds. The control unit clicks once when the position has been deactivated.

# 7. Operation

## 7.5.5 Plug detection

The control unit detects whether a lifting column is plugged in at a specific socket. The control unit also detects whether a lifting column has been changed.

If a lifting column is missing or has been replaced, the control unit clicks three times. The display also shows a fault code (see list of faults in Section 8) if the handset has a display.

A manual reset must be performed to rectify the fault, (see Section 7.4.4 for further details).

## 7.5.6 Auto detect number of drives

Besides plug detection, the control unit can also automatically detect the number of lifting columns plugged in. This feature is always active during first startup of the control unit and after returning the control unit to factory settings (see section 7.5.10). Lifting columns plugged in after the first startup of the control unit will not be detected automatically. For changing the established configuration the control unit has to be returned to factory settings.

### Possible situations:

- The control unit is being used for the first time
- The control unit has been returned to factory settings

## 7.5.7 Collision detection ISP (Intelligent System Protection)

ISP (Intelligent System Protection) is a collision guard. This reduces damage to the system in the case of a collision.



### Hinweis

The sensitivity and the achievable shutdown threshold of ISP depend on the entire system (mechanical and electrical components).



### Hinweis

As soon as the collision protection ISP has braked the height-adjustable table top, the first movement of the table top can only be in the opposite direction after the collision protection ISP action (not in the direction in which the collision protection ISP was activated)



### Hinweis

The switch-off threshold of the ISP can be set with parameters.



# 7. Operation

## 7.5.8 Collision detection (Drive back)

The desk top automatically changes its position by a defined distance in the opposite direction after triggering a safety function (through collision detection ISP or optional accessory, e.g. crush guard). This prevent parts of the body from being permanently trapped.





	<b>Note</b>
	The drive back function is only active if a collision detector (ISP or optional accessory, e.g. switch or crush guard) is available.

	<b>! Warnung</b>
	<p><b>Warnung!</b></p> <p>In exceptional cases however, there can be a crushing hazard despite the collision protection since not only the motor control unit is responsible for the motor shutdown, but the interoperation of mechanical equipment and electronics. Furthermore, the shutdown sensitivity is influenced by mechanical equipment, motor and environmental conditions.</p> <p>For these reasons, Hettich, as the distributor, can therefore not completely rule out this residual risk and does not assume and liability!</p>

## 7.5.9 Changing desk height unit (cm or inch)

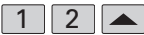
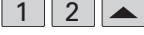
This function lets you change the handset display from centimetre to inch and vice versa. This function does not alter desk height.

	<b>Note</b>
	On selecting the menu, the display shows <b>S</b> and a number, e.g. S 1. This number depends on the control unit's parameters.

No.	Button	Function
1.		Simultaneously press <b>memory position button 1</b> , <b>memory position button 2</b> and the <b>desk top down</b> button.
2.		Keep this button combination pressed for approx. 3 seconds.
3.		Now release the buttons.
4.	  	<p>The display shows <b>S 1</b>.</p> <p>Keep pressing the <b>desk top up</b> button until the display shows <b>S 5</b>.</p>
5.	  	<p>The display shows <b>S 5</b>.</p> <p>Press the <b>SAVE</b>-button.</p> <p>If the display was previously set to cm, it will now be changed to inch. If the display was previously set to inch, it will now be changed to cm.</p>

# 7. Operation

## 7.5.10 Returning control unit to factory settings (S0 menu)





This function allows you to return the control unit to factory settings.

	<b>Note</b>
This procedure requires a handset with display.	

	<b>Note</b>
On selecting the menu, the display shows <b>S</b> and a number, e.g. S 1. This number depends on the control unit's parameters.	



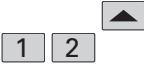
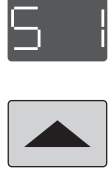



If you have a handset with display (such as LegaDrive Touch Inlay or LegaDrive Touch Comfort), proceed as follows:

To be able to use the control unit again after changing a lifting column's configuration in this way, proceed as follows:

No.	Button	Function
1.		Simultaneously press <b>memory position button 1</b> , <b>memory position button 2</b> and the <b>desk top down</b> button.
2.		Keep this button combination pressed for approx. 3 seconds.
3.		Now release the buttons.
4.		The display shows <b>S 1</b> .  Keep pressing the <b>desk top up</b> button until the display shows <b>S 0</b> .
5.		The display shows <b>S 0</b> .  Press the <b>SAVE</b> -button. The control unit is reset to factory settings. The control unit is now in the same state as during initial commissioning.
6.		Handset display shows fault code <b>E70</b> .
7.		Unplug the control unit's power supply and wait at least 5 seconds.
8.		Plug the control unit's power supply back in again.
9.		Carry out a manual reset (see Section 7.4.4 for details).

# 7. Operation

If a handset with only one up and one down button is used, proceed as follows:

No.	Button	Function
1.		Disconnect the power supply of the control unit and wait at least 5 seconds.
2.	 and 	While the control unit is disconnected from mains power, press the desk position down and desk position up buttons simultaneously. Press and hold this key combination.
3.	 and 	Keep this key combination of desk top down and desk top up pressed while reconnecting the control unit to mains power.
4.	 and 	Keep this key combination of desk top down and desk top up pressed until the control unit begins to click twice per second. Release the two buttons as long as the control unit clicks twice per second.  The control unit is reset to factory settings. The control unit is now in the same state as during initial commissioning.
5.		Unplug the control unit's power supply and wait at least 10 seconds.
6.		Plug the control unit's power supply back in again.
7.		Carry out a manual reset (see Section 7.4.4 for details).

# 8. Troubleshooting

Lifting column system malfunctions must only be rectified by specialists instructed to do so by the person responsible.

In identifying the source of malfunction attention must be paid to the entire area surrounding the lifting column system. The manufacturer must be immediately notified of any damage occurring during the warranty period.

## 8.1 Safety advice



### Warning

Safety regulations while identifying the source of malfunction and rectifying malfunction!

Observe the accident prevention regulations!

In the event of a mechanical malfunction, make sure that the lifting column system is disconnected from the power supply!

The lifting column system must be disconnected from the power supply before commencing troubleshooting!

Disconnect the power supply cable from mains power supply and take action to prevent it from being plugged back in unintentionally.

# 8. Troubleshooting

## 8.2 Malfunctions

This section provides you with detailed information on the following subjects:

- Potential malfunctions and how to remedy them
- Fault messages on the handset display
- Control unit click codes

### 8.2.1 Potential malfunctions and how to remedy them

#### Lifting columns not working

Possible cause	Remedy
Power supply cable is not plugged in.	Plug the power supply cable into the control unit.
Lifting columns are not plugged in.	Plug the lifting column cable into the control unit.
Power supply cable faulty (e.g. cable break)	Change the power supply cable.
Poor plug contact	Properly plug in the lifting column cable, the power supply cable and the handset cable.
Control unit faulty	Contact customer service.
Handset faulty	Change the handset.
Lifting column faulty	Contact customer service.

#### Lifting columns only operating in one direction

Possible cause	Remedy
Power failure during height adjustment or power supply cable unplugged during height adjustment.	Carry out a manual reset (see Section 7.4.4. *)
Control unit faulty	Contact customer service.
Handset faulty	Change the handset.
Lifting column faulty	Contact customer service.

\*) if the drives are only providing downward movement.

# 8. Troubleshooting

## Display not working (buttons working)

Possible cause	Remedy
Cable is faulty	Change the handset
Display is faulty	Change the handset
Microcontroller is faulty	Change the handset
Handset is faulty	Change the handset

## Buttons not working (display working)

Possible cause	Remedy
Cable is faulty	Change the handset
Handset is faulty	Change the handset
Buttons were pressed on startup	Unplug the handset and then plug it back in again without touching the control panel

## Control unit or handset not working (neither display nor buttons)

Possible cause	Remedy
Cable is not plugged in.	Plug the cable into the socket intended for it and marked HS
Cable is not plugged in properly.	Plug the cable into the socket intended for it and marked HS
Poor plug contact	Unplug the cable and then plug it back in properly
Cable faulty	Change the handset
Handset is faulty	Change the handset
Poor plug contact	Properly plug in the lifting column cable, the power supply cable and the handset cable.
Wireless handset faulty	a) No battery in the wireless handset or battery empty. (Refer to section 6.2.2.2 "Replacing the battery"). b) Wireless handset not programmed. (Refer to section 6.2.2.1 "Programming").

## 8.2.2 Faults indicated on the handset display



The display shows HOT.

Possible cause	Remedy
The control unit is protected from overheating. Overheating has activated this overheating protection.	Wait for the control unit to cool down and the HOT message to go out on the display. The control unit is now ready for operation again.



The display shows four dashes.

Possible cause	Remedy
The display handset was connected to the control unit while the control unit was connected to mains power voltage.	Disconnect the power cable from the mains power voltage. Leave the control unit voltage-free for approx. 10 seconds. Reconnect the power cable to the mains power.



The display shows E + a fault number.

Possible cause	Remedy
An internal fault has occurred in the control unit.	Proceed as described in the following fault list.

## 8. Troubleshooting

	Description	Remedy
00	Internal fault on channel 1	Switch the control unit off. Contact customer service.
01	Internal fault on channel 2	
12	Fault on channel 1	Unplug the control unit. Rectify the external short circuit. <b>Or:</b> Plug in the correct lifting column at the socket concerned.
13	Fault on channel 2	Put the control unit back into operation.
24	Motor M1 overcurrent	Remove the trapped objects from the adjustment zone. If desk overloaded: Remove load from desk. Contact customer service.
25	Motor M2 overcurrent	
36	Plug detection on motor socket M1	Plug in the correct lifting column at the socket concerned.
37	Plug detection on motor socket M2	Carry out a manual reset (see Section 7.4.4).
48	Motor group 1 overcurrent	Remove the trapped objects from the adjustment zone. If desk overloaded: Remove load from desk. Contact customer service.
49	Motor group 2 overcurrent	
55	Motor group 1 cannot be synchronised	Remove load from desk. Carry out a manual reset (see Section 7.4.4).
56	Motor group 2 cannot be synchronised	If the fault is still shown after resetting, contact customer service.
60	Collision detection	Remove the trapped objects from the adjustment zone. If desk overloaded: Remove load from desk. Contact customer service.
61	Motor changed	Plug in the correct lifting column at the socket concerned. Carry out a manual reset (see Section 7.4.4).
62	Control unit over-current	Remove the trapped objects from the adjustment zone. If desk overloaded: Remove load from desk. Contact customer service.
67	Voltage too high	Unplug the power supply cable and contact customer service.
70	Changed drive configuration	See section 7.5.5

81	Internal fault	Carry out a manual reset (see Section 7.4.4). If the fault is still shown after resetting, unplug the power supply cable and plug it back in again after a few seconds. If this fault occurs on a regular basis, unplug the power supply cable and contact customer service.
93	Connection error in the cascaded combination. The error is shown on the display for 15 seconds, the control unit then switches to the reset mode with flashing display <b>000</b> , if necessary.	Check all cable connections and try to perform a drive reset. If the drive reset is not possible, disconnect all control units from the power supply. Wait for at least 10 sec. and reconnect all control units to the power supply. Try to perform a drive reset again. If a drive reset is still not possible after this, contact Customer Service.

i	Note
	<p><b>PowerFail Detection</b> is identifying power failures and saving all relevant data before the voltage drops below a critical level.</p> <p>In a few cases of exception data cannot be saved. The next time the control unit is switched on, the display then shows <b>E81</b> and the control unit clicks three times. A <b>manual reset</b> must be performed to rectify this fault (see Section 7.4.4).</p>

# 8. Troubleshooting

## 8.2.3 Control unit click codes

As soon as the control unit is supplied with power, it uses the built in relays to generate acoustic signals informing the user of system status as well as of the reason for the last shutdown. The table below shows the number of clicks generated and the information they provide.



Number of clicks	Status information
2x	<b>Normal operation:</b> The system is working without any problem.
1x	<b>Emergency operating mode:</b> The system is in emergency mode, the drives cannot be used. Check the fault code on the handset display.
3x to 6x	<b>Last shutdown not completed / forced reset:</b> Check the error code on the handset display. If the control system was unable to complete a data saving process, e.g. before a power failure, it will click 4 - 5 times on restarting and go into reset mode - in this case, however, without displaying error code 81.



# 9. Servicing and maintenance



- Regularly check the electrical system in accordance with VDE guidelines.
- Meet all national provisions/regulations.
- Clean the entire desk support at least every 2 weeks (recommended).



The life of the lifting column system LegaDrive Eco will depend on proper use and adherence to regular servicing intervals.



	 <b>Warning</b>
	<p><b>Risk of injury!</b> Servicing and maintenance work must only be carried out by instructed, skilled personnel.</p>



	<b>Note</b>
	<p>If lifting columns are replaced in a system, it is imperative to return the lifting columns to factory settings first (see Section 7.5.10) and perform a manual reset (see Section 7.4.4).</p>

## 9.1 Safety advice

	 <b>Warning</b>
	<p><b>Risk of injury!</b></p> <ul style="list-style-type: none"> <li>• Only carry out servicing work with the lifting column system shut down.</li> <li>• Make sure the lifting column system is prevented from switching back on unintentionally.</li> <li>• Follow the safety advice and accident prevention regulations when using oils/lubricants, cleaning agents and replacement parts of the respective manufacturer!</li> </ul>

	 <b>Danger</b>
	<p><b>Danger to life!</b> Servicing work on the lifting column system's electrical connections or on the electrical auxiliary / control connections must only be carried out by qualified electricians. <b>The lifting column system must be disconnected from the power supply before commencing troubleshooting!</b> Disconnect the power supply cable from mains power supply and take action to prevent it from being plugged back in unintentionally.</p>



	 <b>Warning</b>
	<p><b>Risk of injury!</b></p> <ul style="list-style-type: none"> <li>• The basic safety advice provided in the sub-suppliers' documentations must be followed.</li> <li>• The manufacturer does not allow any flame cutting, welding, soldering and grinding work to be performed on the lifting column system.</li> </ul>

	 <b>Danger</b>
	<p><b>Danger to life from manipulating the protective guards!</b> Manipulated protective guards will not provide any protection in the event of a hazard. This may lead to fatal injuries to personnel and damage to the lifting column or other property.</p> <ul style="list-style-type: none"> <li>• Safety devices must never be removed or rendered ineffective for assembly / reassembly and repair work.</li> </ul>

# 9. Servicing and maintenance

	<b>Warning</b>
	<p><b>Risk of injury from failure to observe safety measures!</b></p> <p>Any failure to follow safety measures may lead to injury to the persons present at the desk support and to serious damage. Before commencing and while performing work involved in servicing, maintenance and troubleshooting activities implement the applicable safety measures and follow them.</p>

	<b>Warning</b>
	<p><b>Risk of injury from failure to observe safety measures!</b></p> <p>The enclosures around the LegaDrive and LegaDrive Eco's components must not be opened, removed or damaged.</p> <p>Failure to observe this warning may result in injuries!</p>

 	<b>Warning</b>
	<p><b>Risk of falling/tripping hazard!</b></p> <p>Dirt, remains of consumables and auxiliary substances as well as any replacement parts and tools left lying about present a risk of falling or tripping hazard.</p> <p>Persons can suffer serious injuries from falling.</p> <ul style="list-style-type: none"><li>• Keep the workplace, in particular handles, steps etc., free of dirt.</li><li>• Dispose of consumables and auxiliary substances in the proper manner and carefully put away replacement parts and tools.</li></ul>

	<b>Note</b>
	<p>Improper maintenance will result in damage to the desk support!</p> <p>Improper disassembly and assembly may result in property damage or consequential damage to the desk support.</p> <p>Therefore, when carrying out any removal or dismantling activity, always:</p> <ul style="list-style-type: none"><li>• mark which parts belong together</li><li>• mark and note down the place where parts are fitted</li><li>• remove and keep assemblies separately from each other</li></ul> <p>After carrying out maintenance work, always:</p> <ul style="list-style-type: none"><li>• check all screw connections to make sure they are tight,</li><li>• close and screw down all covers.</li></ul>

## 9.2 Checking safety devices

Regularly check safety devices to make sure they are complete and in proper working order.



## 9.3 Labelling, information signs

Labelling/information signs must be

- cleaned with a cloth,
- checked for secure attachment and legibility,
- replaced if they are damaged.

# 10. Taking out of service

When taking the system out of service the mains power cable must be disconnected from the mains power supply.

	 <b>Danger</b>
	<p>Danger from electric shock! Work on electrical equipment must only be carried out by authorised electricians!</p>

# 11. Disposal

Sort materials before disposal and dispose of them in an environmentally friendly manner. Electrical and electronic components must be disposed of as hazardous waste.

## 11.1 Protecting the environment



### Caution

#### Caution!

The obligations prescribed in law with regard to avoiding waste and proper recycling/disposal must be met when carrying out any work on the lifting column system!

Particularly when carrying out installation, repair and servicing work, substances hazardous to water, such as

- lubricating greases or
- solvent based cleaning fluids must not be allowed to pollute the ground or enter the sewer system!

These substances must be kept, transported, loaded and disposed of in suitable containers.



### Information

Immediate remove empty button cells (batteries) and dispose of them in an environmentally friendly manner. They must not be discarded with household rubbish!



# 11. Disposal

## 11.2 Disposal

If the lifting columns system LegaDrive Eco is ever taken out of service for good, the laws and regulations in force at that time of disposal must be observed and met.

The entire energy supply system must also be dismantled and removed at the time of final shutdown and disposal.

To avoid danger to life from electric shock:

	 <b>Danger</b>
	<b>Danger from electric shock!</b> The work involved in dismantling and removing the electrical equipment must only be carried out by trained electricians!



The LegaDrive Eco lifting column is an electrical and electronic device which, in compliance with WEEE Directive 2012/19/EU, must be disposed of separately from household waste. The products are labelled with the symbol shown on the left.

Before the disposal of materials and components, check their recyclability. Recycle all parts, if possible.

Dispose of all materials and parts according local guidelines and regulations. Ensure that the disposal is lastingly compatible for humans and nature.





Paul Hettich GmbH & Co. KG  
Vahrenkampstr. 12-16  
32278 Kirchlengern

MTA\_926576800-01\_LegaDriveEco\_en

Technik für Möbel

